

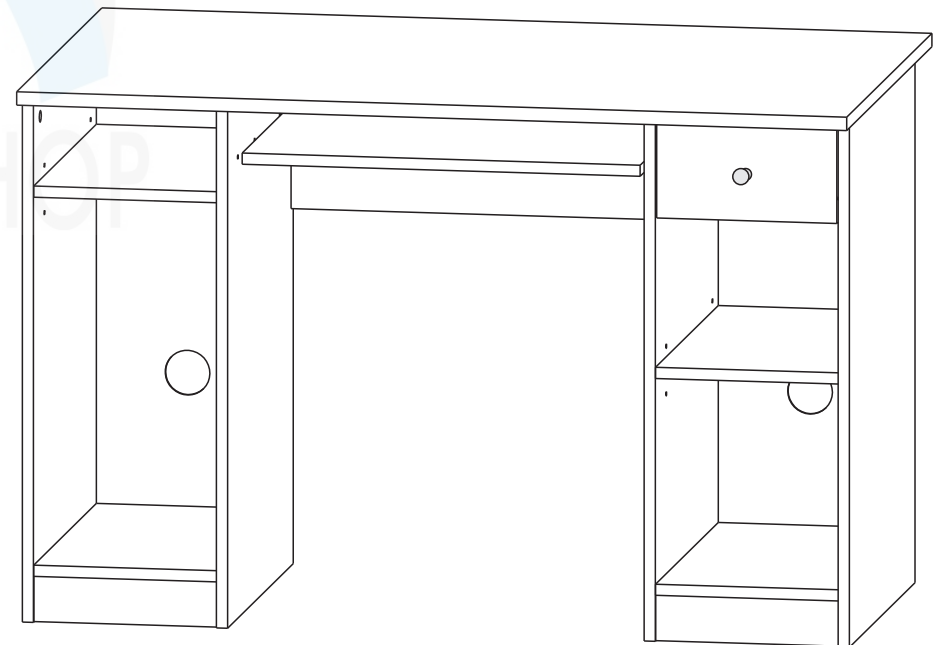

Type:01

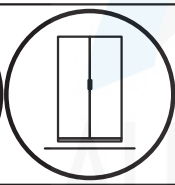

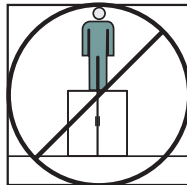

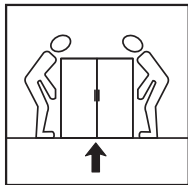
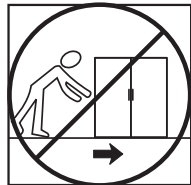
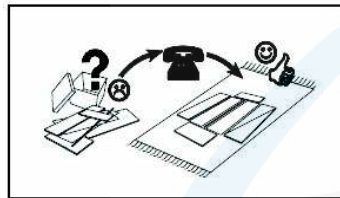
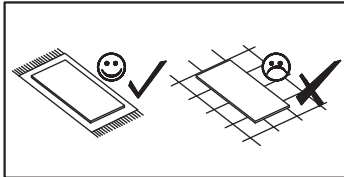
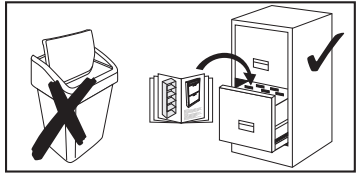
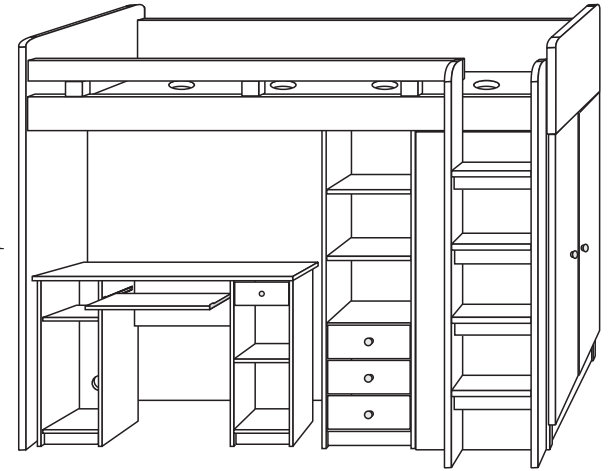
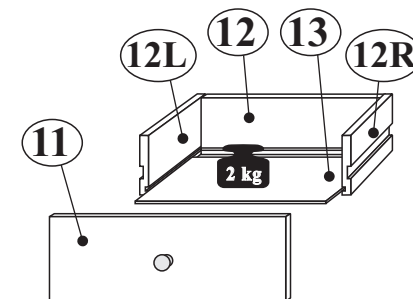
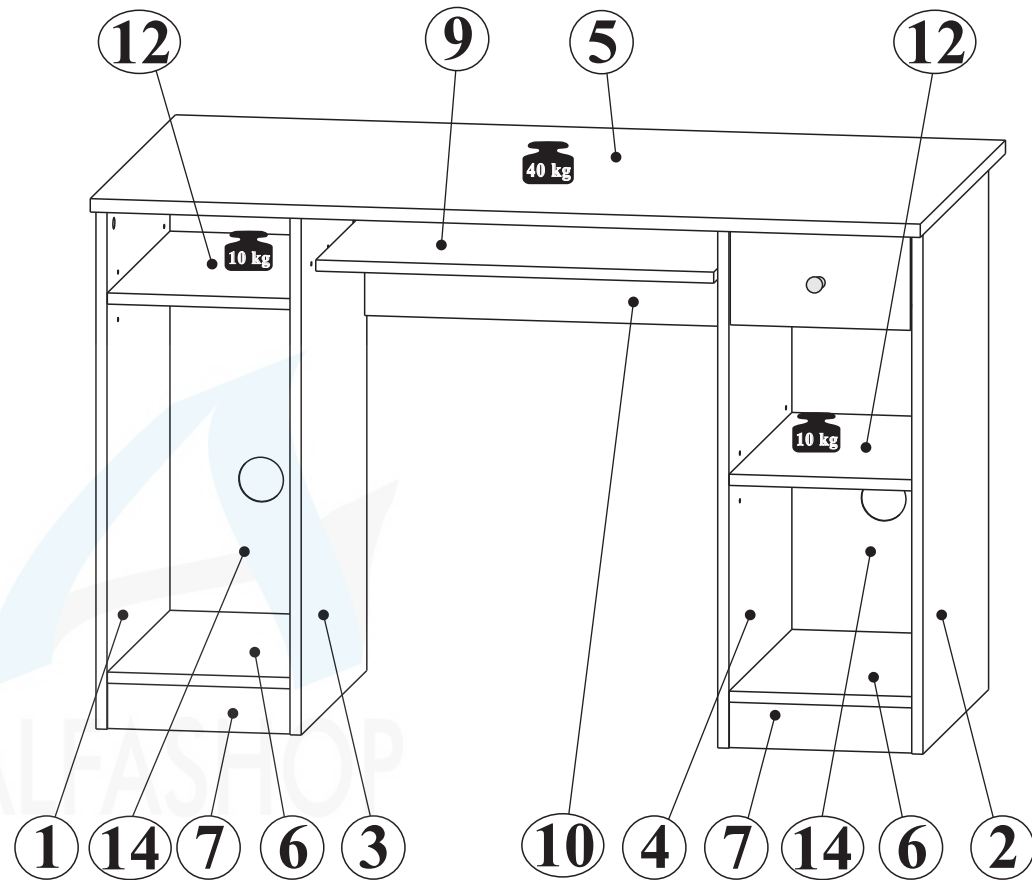
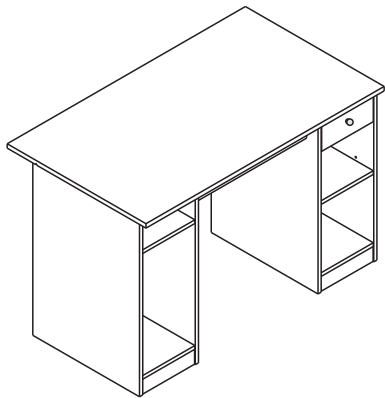

| | | | | |
|---------|------|-----|---|-----|
| 1 | 700 | 500 | 1 | 1/1 |
| 2 | 700 | 500 | 1 | 1/1 |
| 3 | 700 | 500 | 1 | 1/1 |
| 4 | 700 | 500 | 1 | 1/1 |
| 5 | 1116 | 650 | 1 | 1/1 |
| 6 | 246 | 498 | 2 | 1/1 |
| 7 | 246 | 66 | 2 | 1/1 |
| 8 | 246 | 478 | 2 | 1/1 |
| 9 | 535 | 404 | 1 | 1/1 |
| 10 | 560 | 220 | 1 | 1/1 |
| 11 | 242 | 128 | 1 | 1/1 |
| 12L,12R | 402 | 70 | 2 | 1/1 |
| 12 | 213 | 70 | 1 | 1/1 |
| 13 | 224 | 400 | 1 | 1/1 |
| 14 | 628 | 255 | 2 | 1/1 |

NR 1

B1  ϕ 8x28 mm x24

M1  ϕ 15x12mm x20

T1  5x39mm x20

W1  x8

NR 2

F15  x8

J23  x16

C14  ϕ 20mm x4

L1  GLUE LEM x1

NR 3

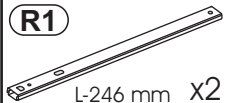
R1  L-246 mm x2

A1  M4x9 mm x2

S3  3,5x13 mm x4

M2  ϕ 12x10mm x2

T2  5x32mm x2

P5  4x30 x2

NR 4

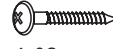
P5  4x30 mm x1

U5  x1

NR 5

R23 L-400 mm  x1L/1R

E24  6,0x11 x6

S3  3,5x13 x6



ALFASHOP

UNIT P5--1T 12

Type:12

4 / 10

1

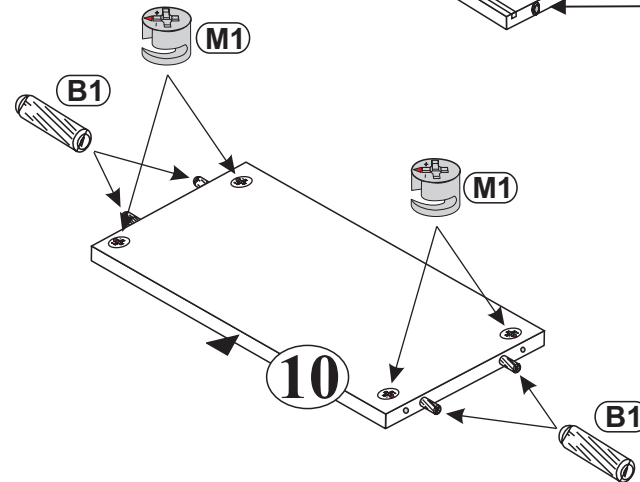
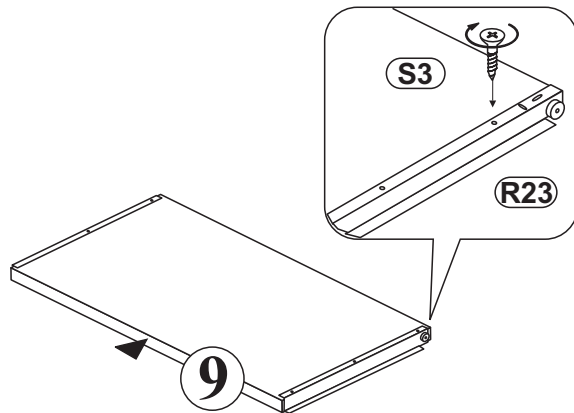
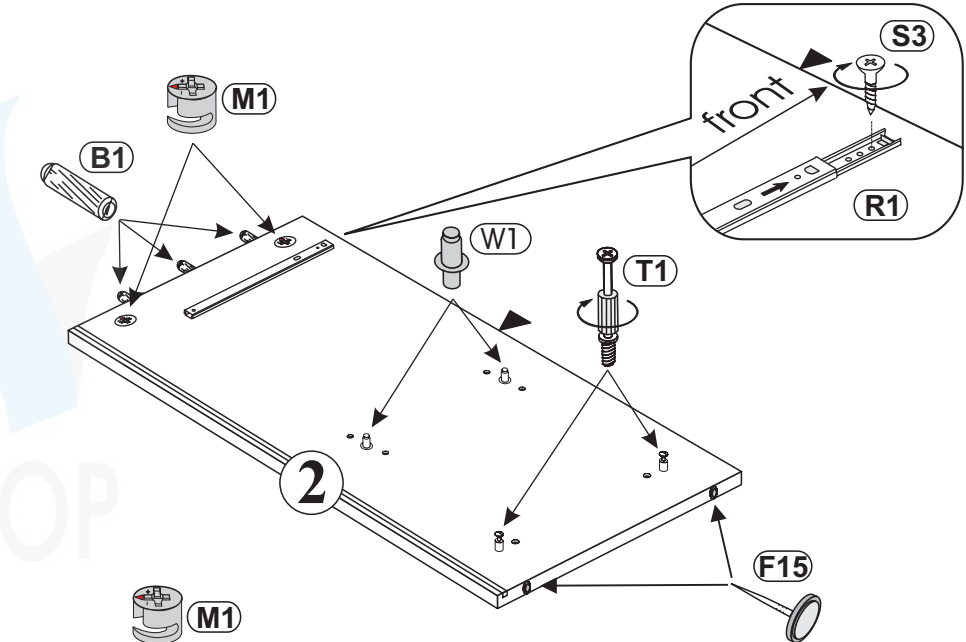
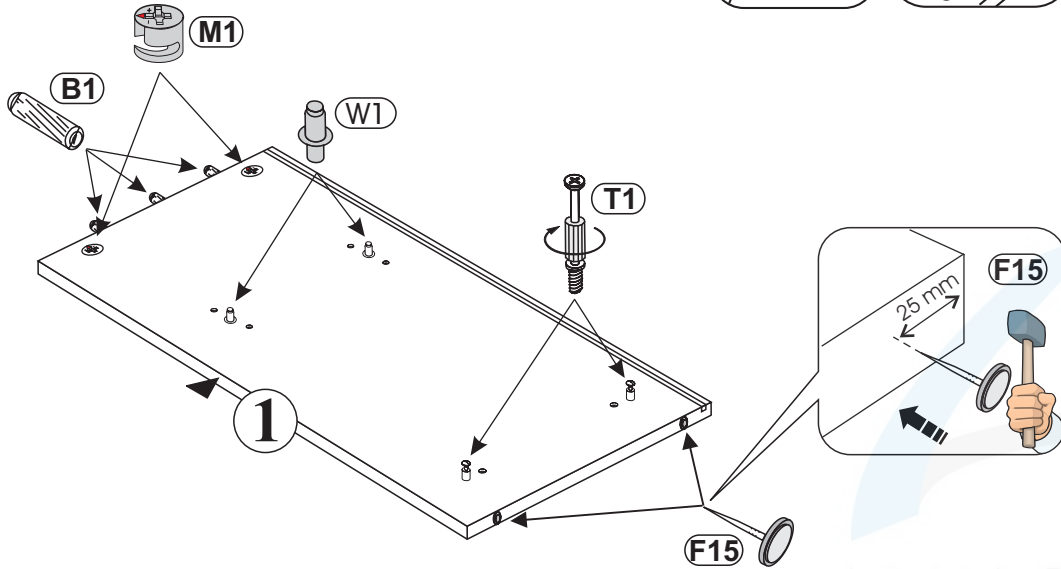
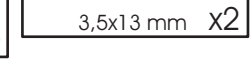
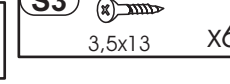
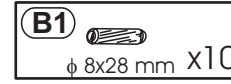
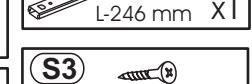
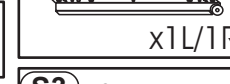
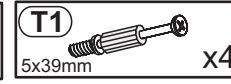
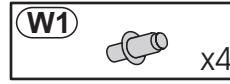
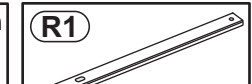
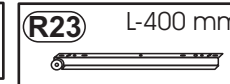
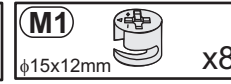
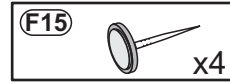
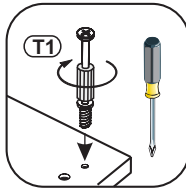
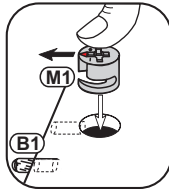
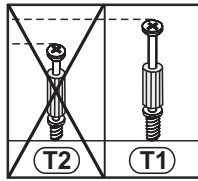
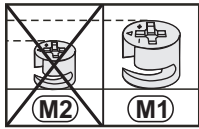

2

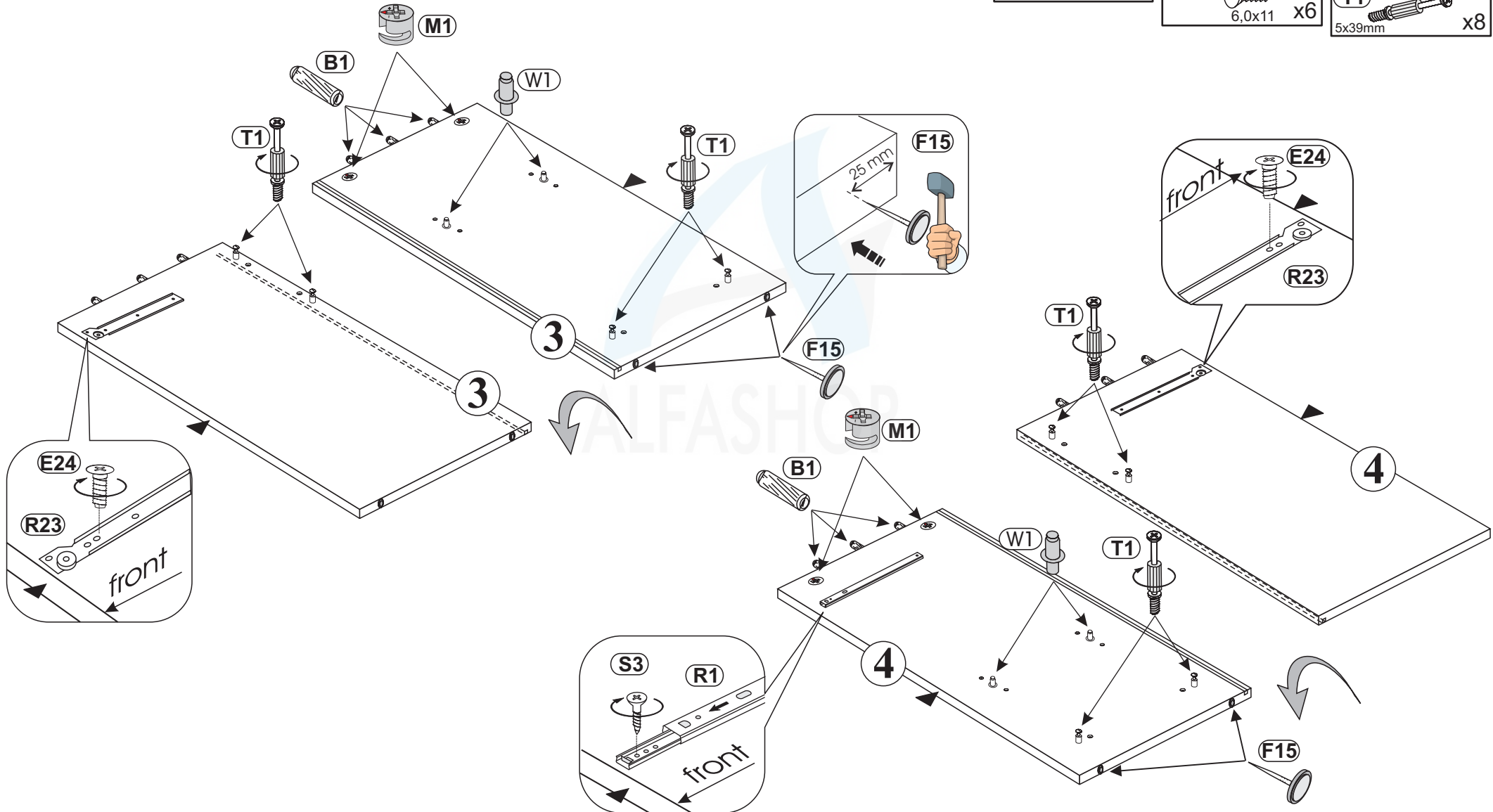
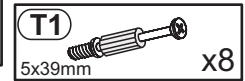
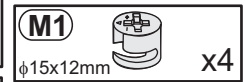
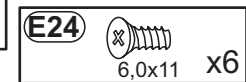
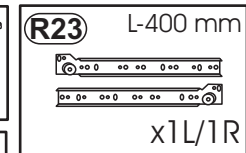
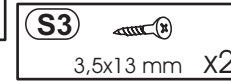
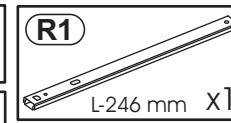
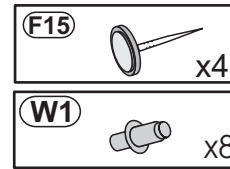
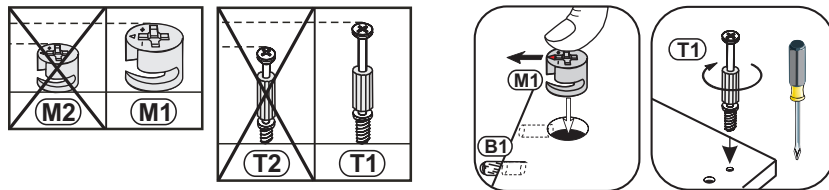

3

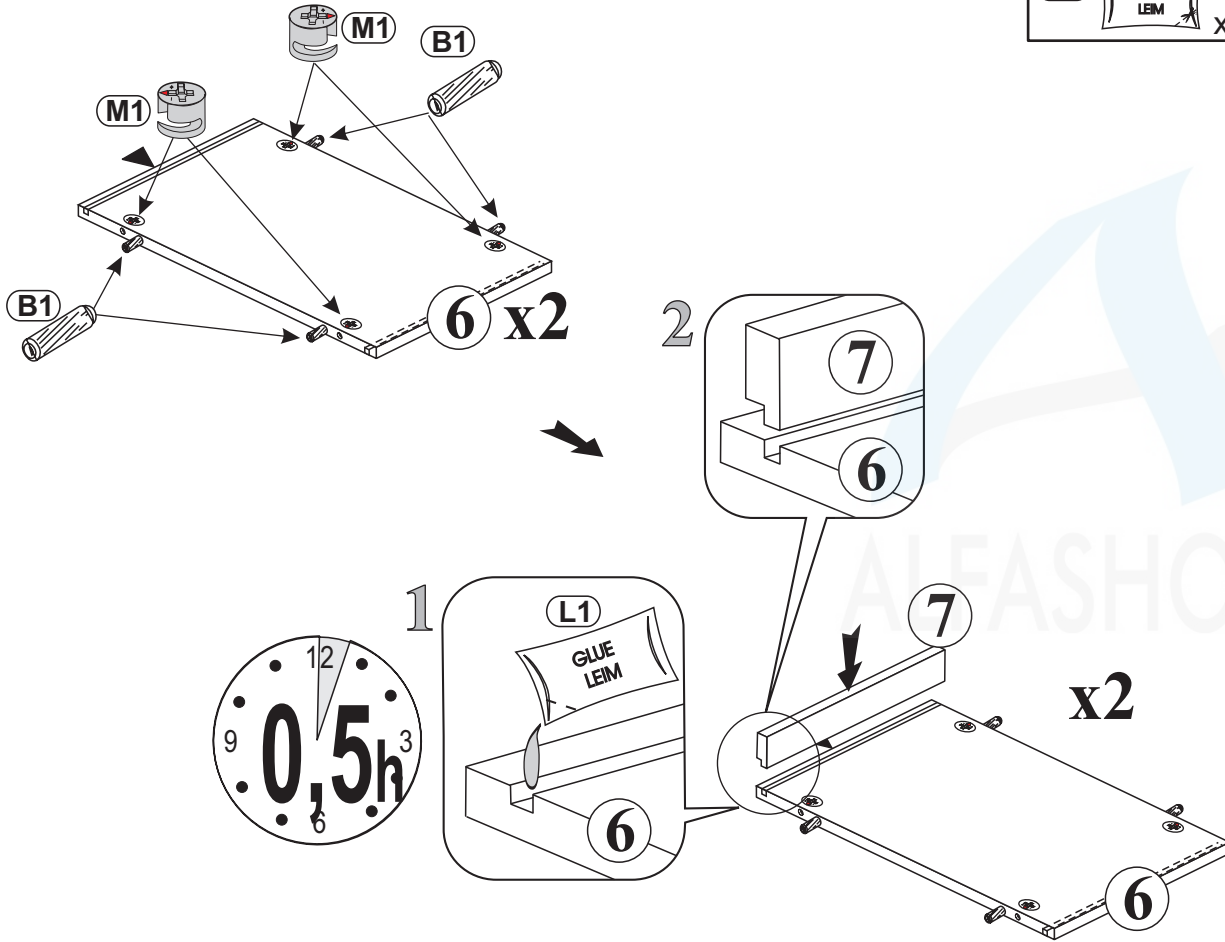
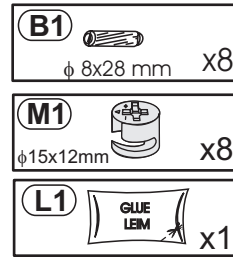
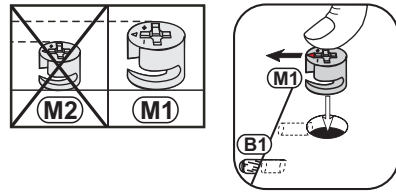

4

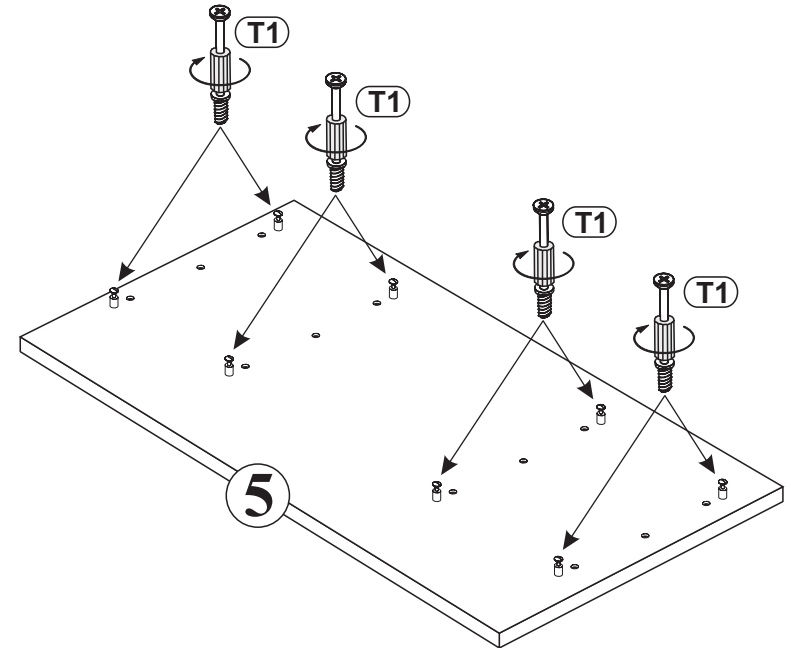
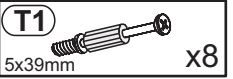
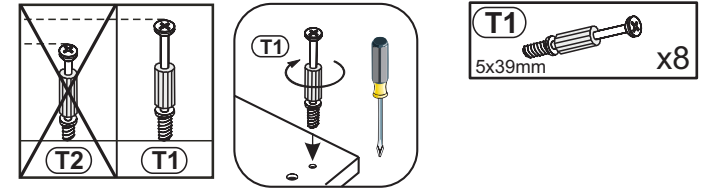

5

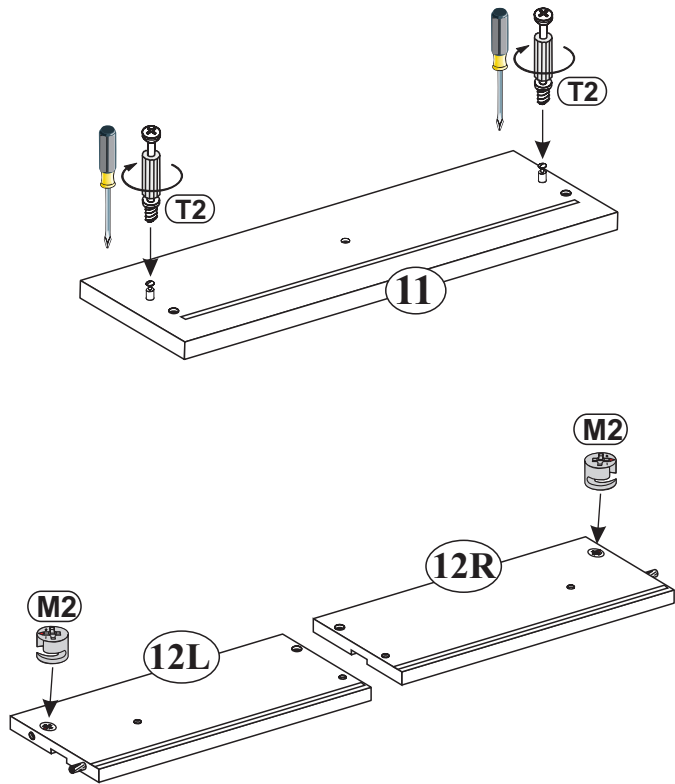
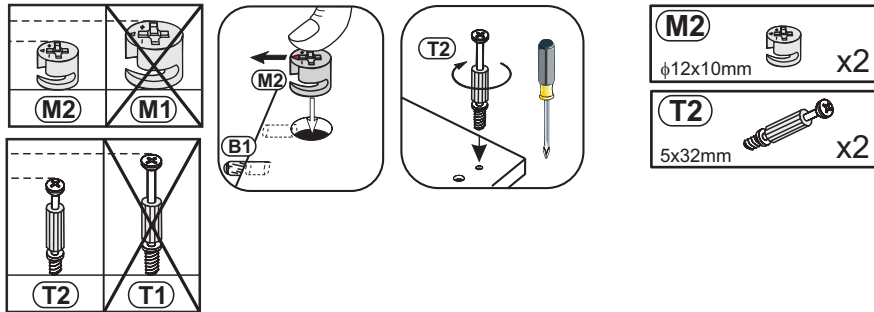

6

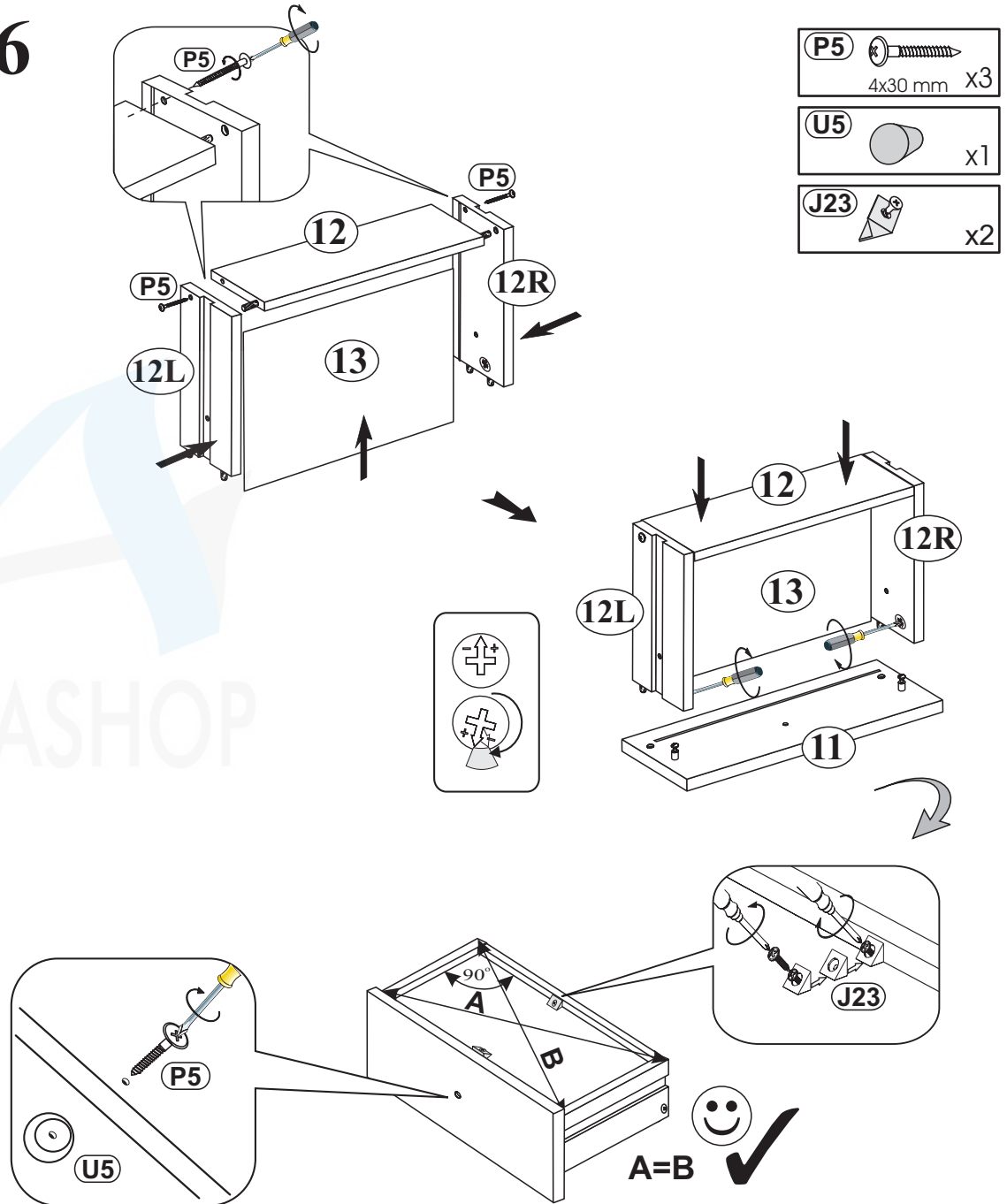

7

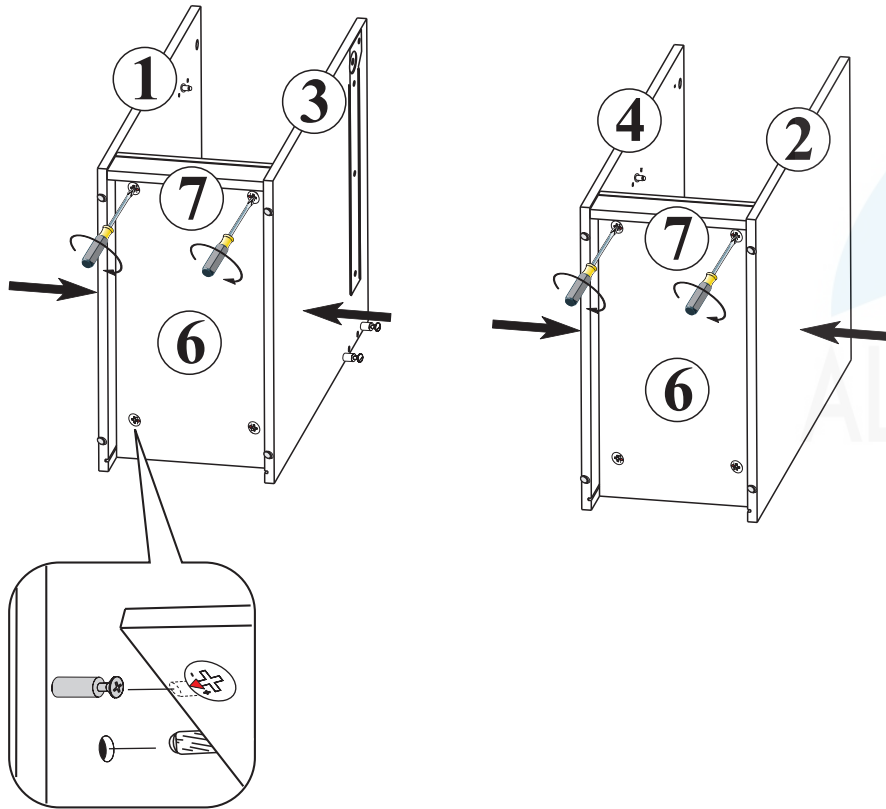

8

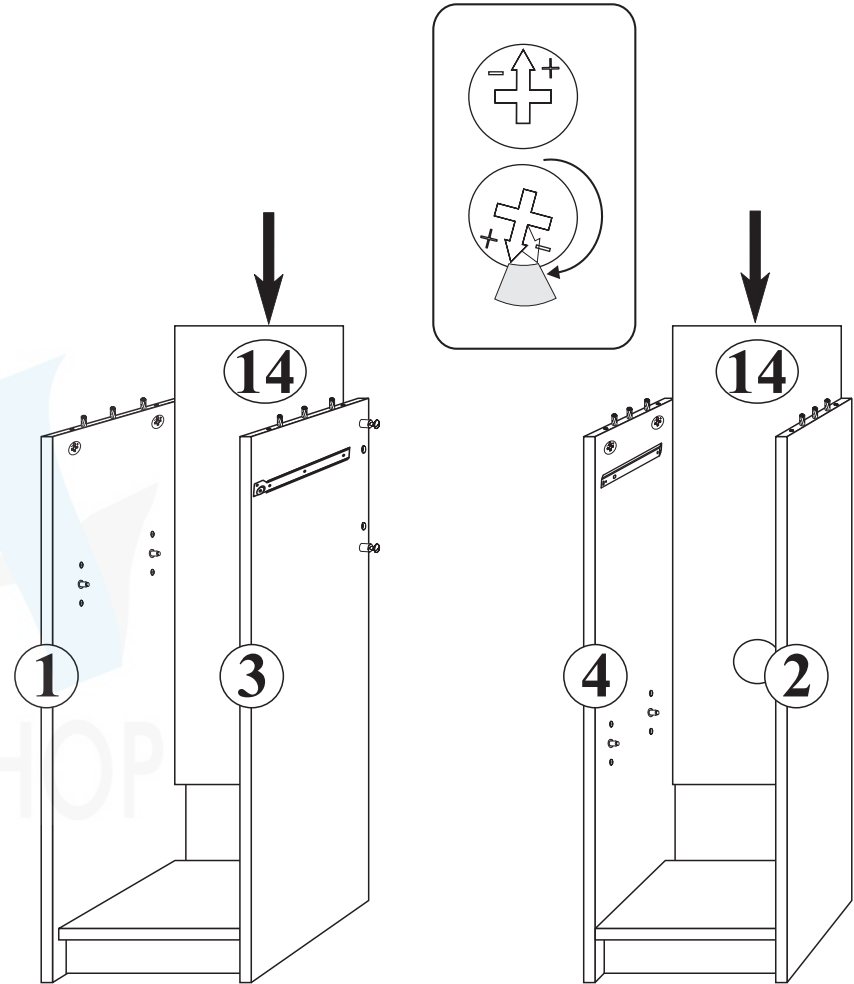

9

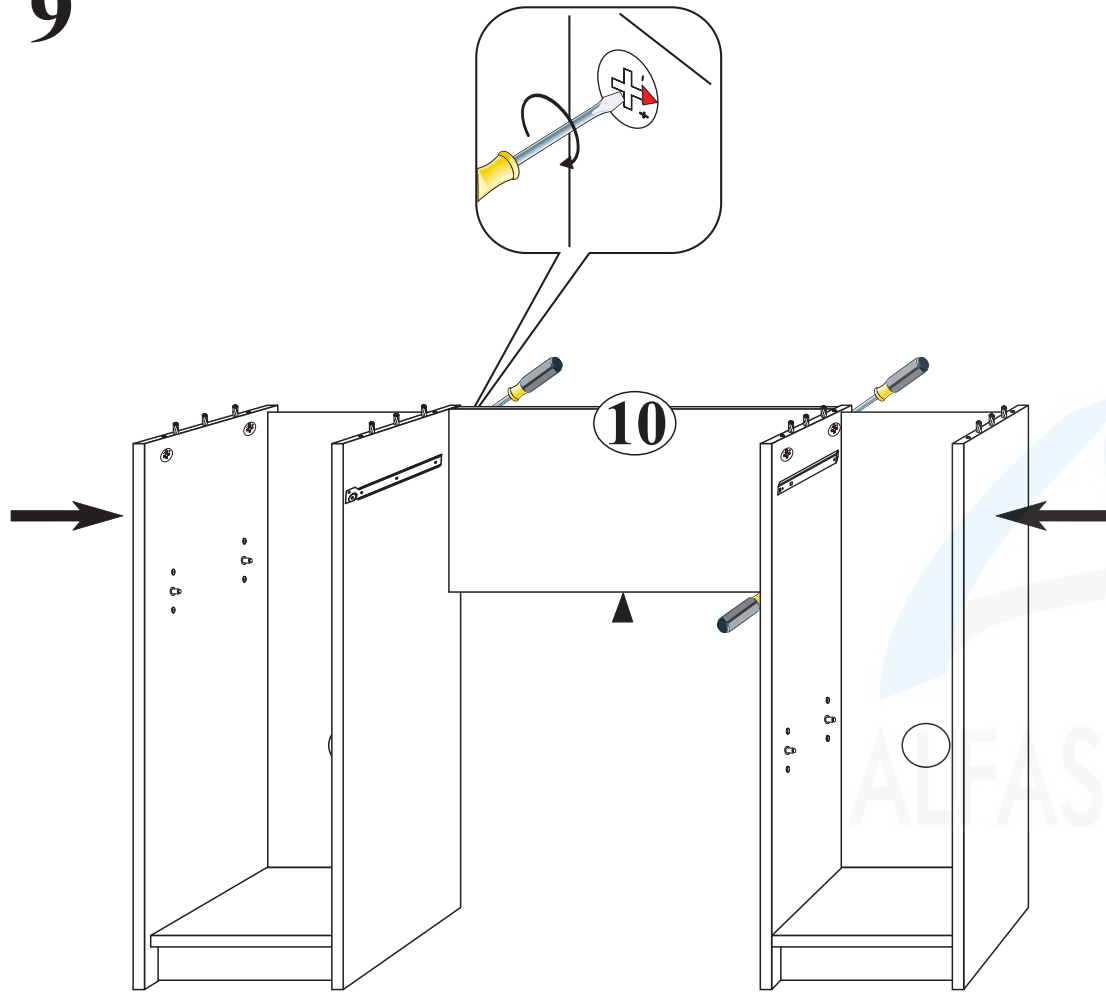

10

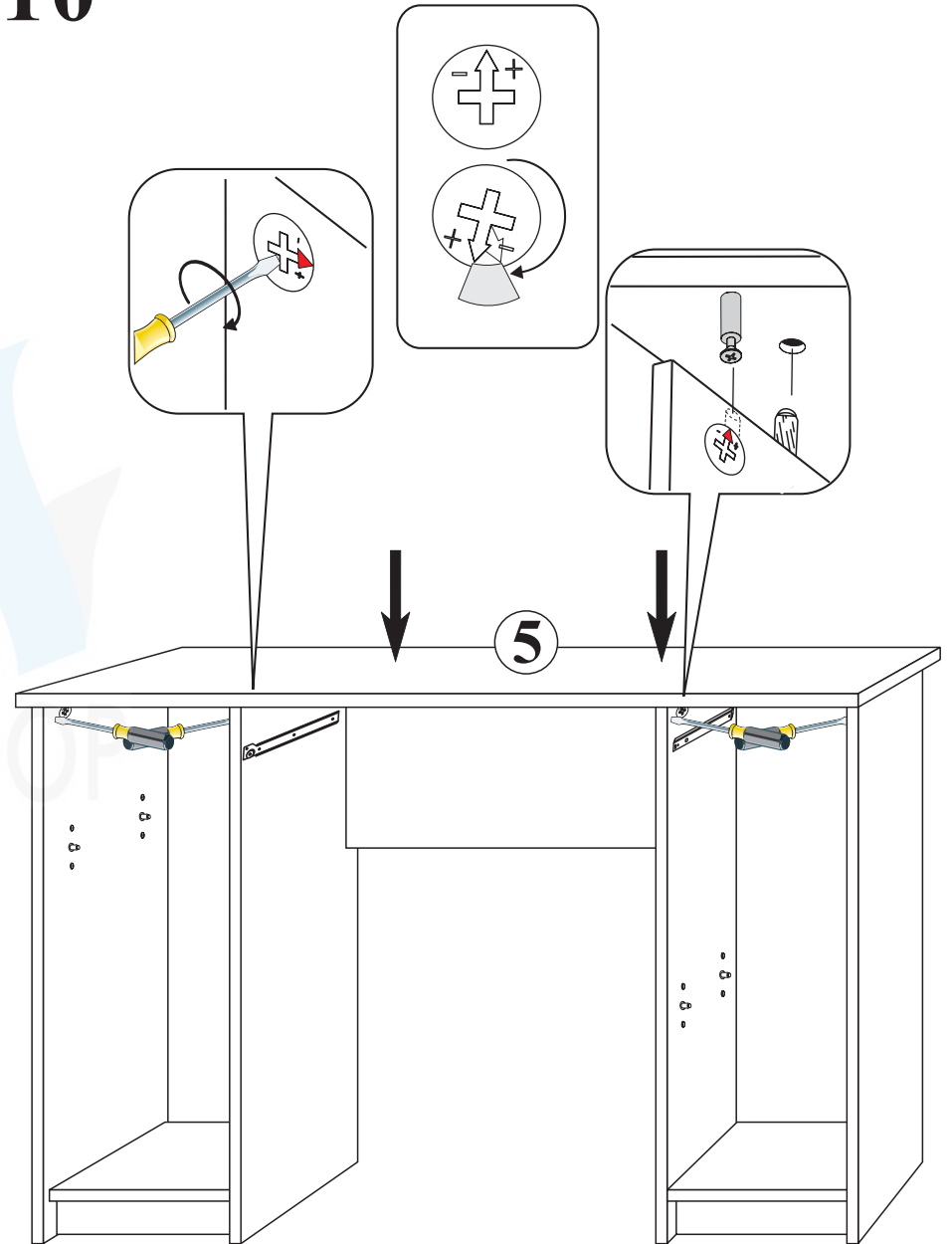

11

J23  x14

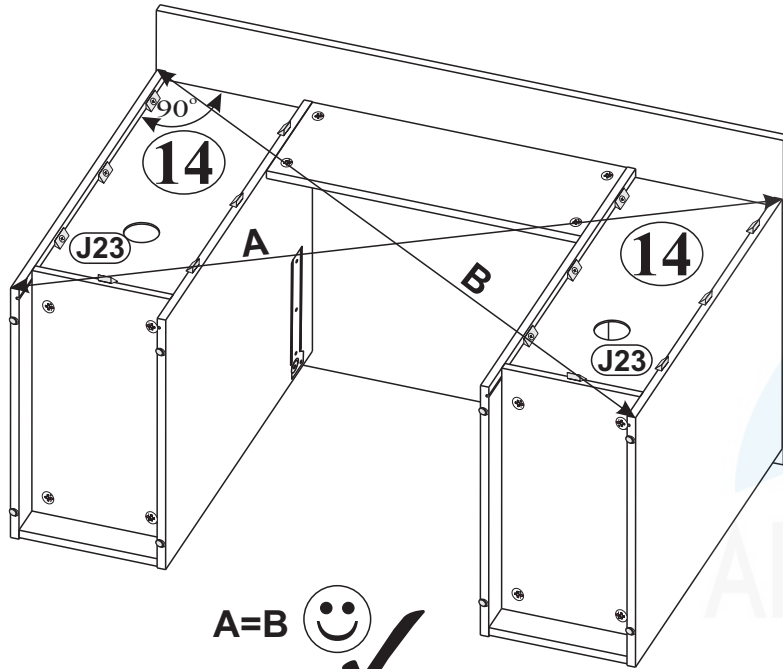

A=B 😊 ✓

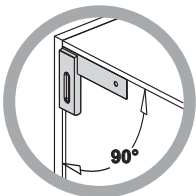
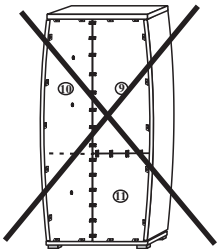

1

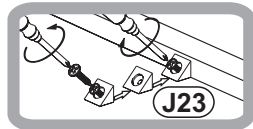

2

12

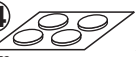
C14  x4
φ20mm

A1  x2
M4x9 mm

