

Option "a"

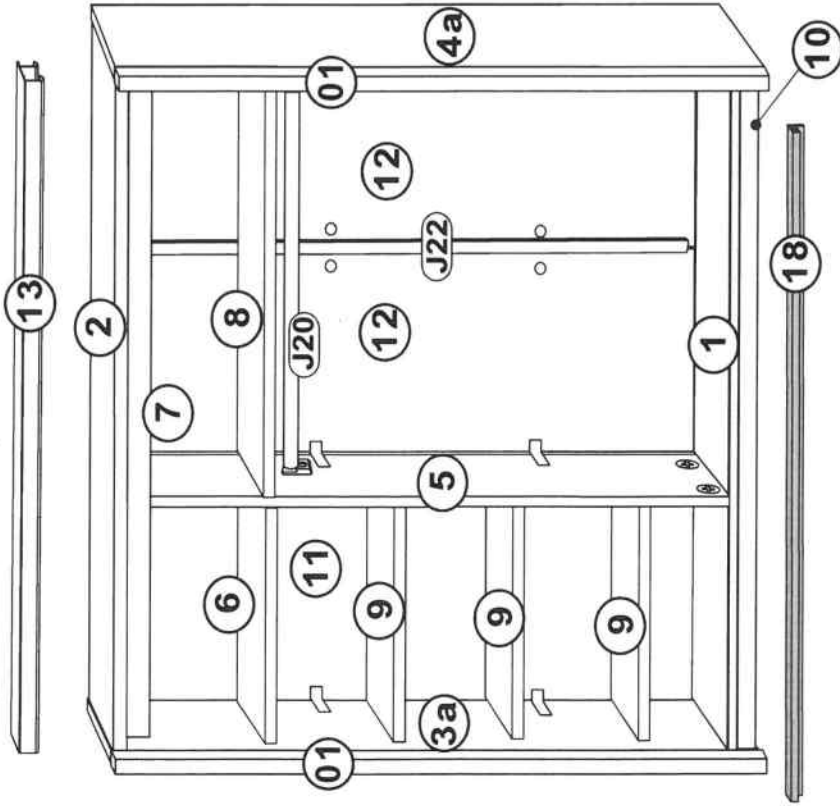

option "b"

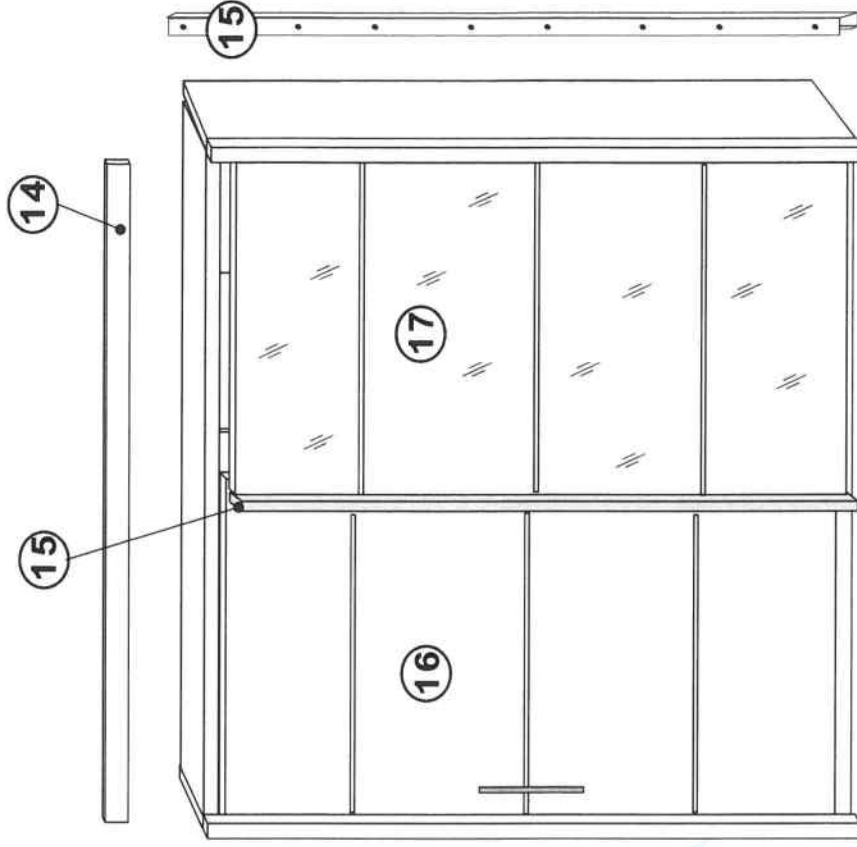
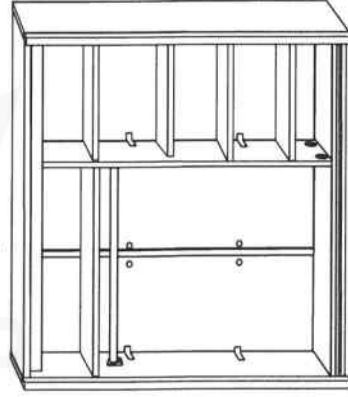

A vertical strip of icons on the right side of the page. From top to bottom: a circular icon with a crossed-out coffee cup and steam; a circular icon with a coffee cup and steam; a circular icon with a crossed-out hand holding a screwdriver; a circular icon with a clock face showing 3.0h; a set of icons showing a box being opened and a screwdriver being used; a set of icons showing a box being opened and a screwdriver being used; a set of icons showing a person using a screwdriver; a set of icons showing a person using a screwdriver; a set of icons showing a box being opened and a screwdriver being used; a circular icon with a crossed-out person holding a screwdriver.

option "c"

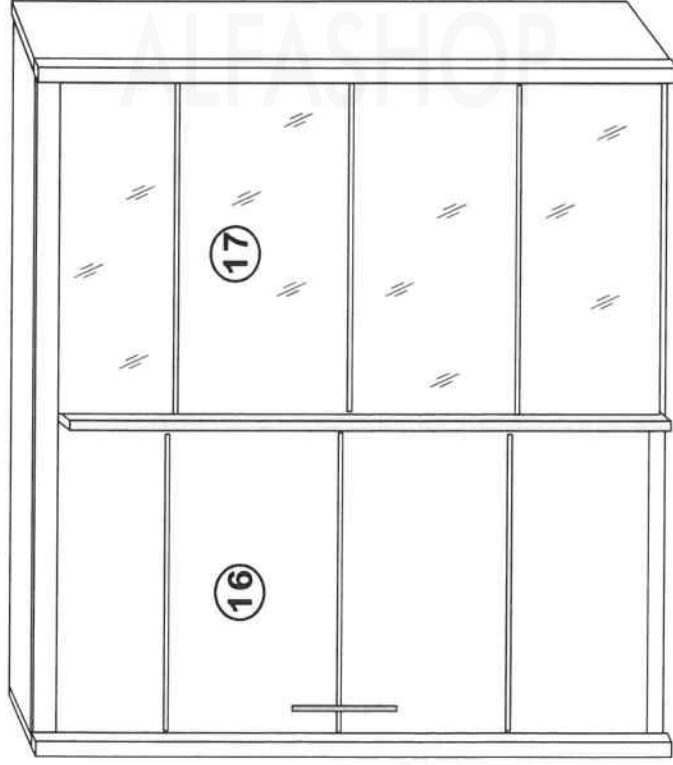

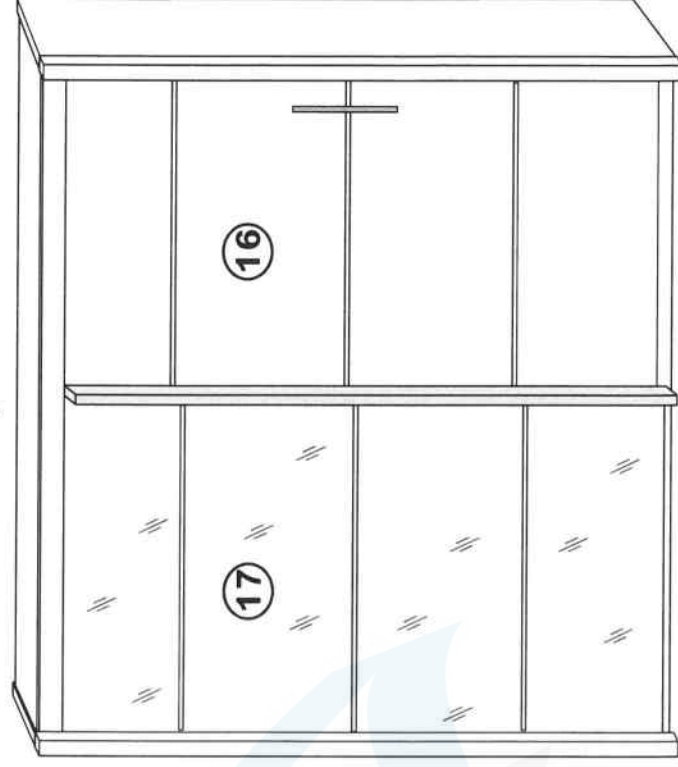

option "d"

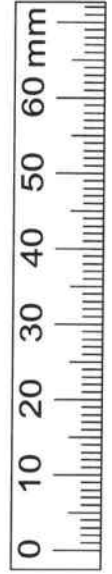
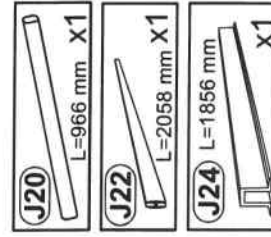
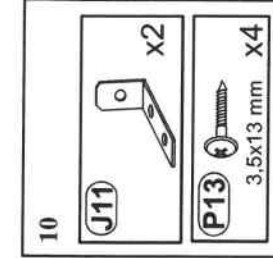
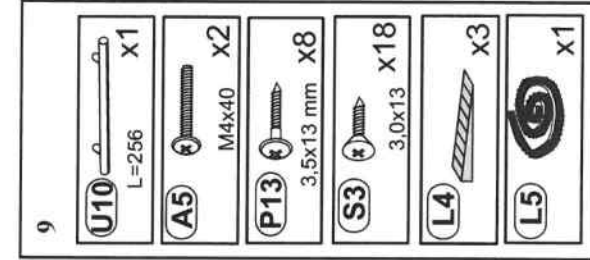
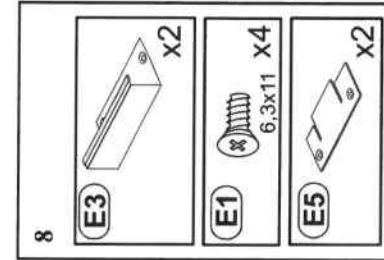
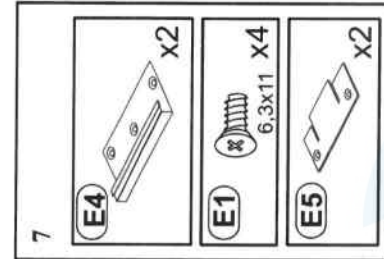
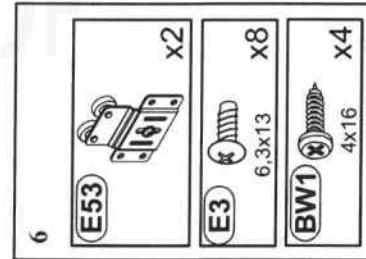
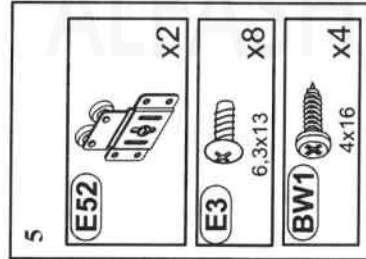
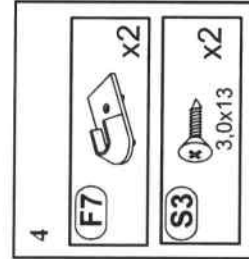
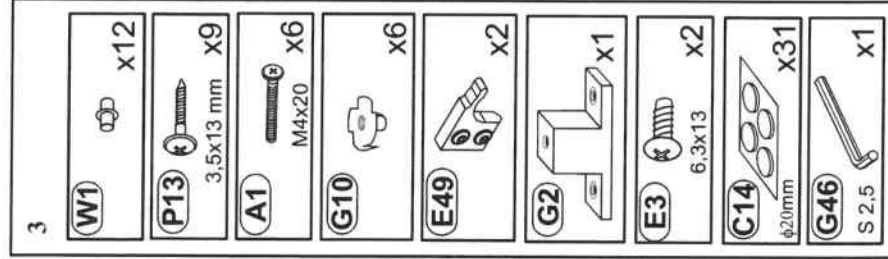
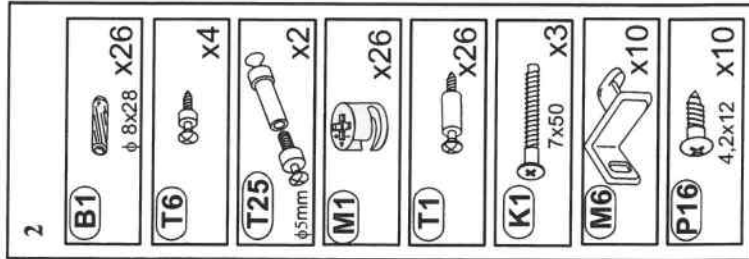



1

- (B1)  ϕ 8x28 x12
- (M1)  x10
- (T1)  x10

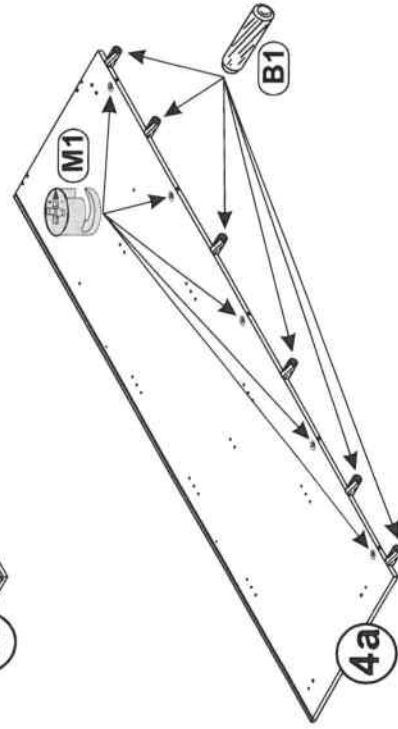
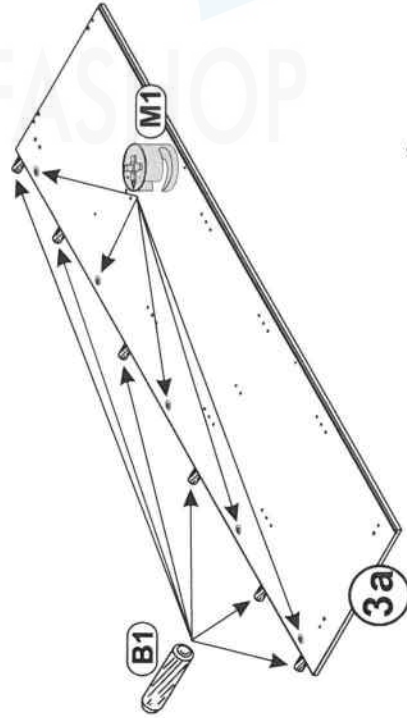
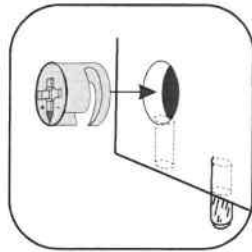
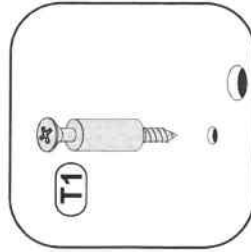
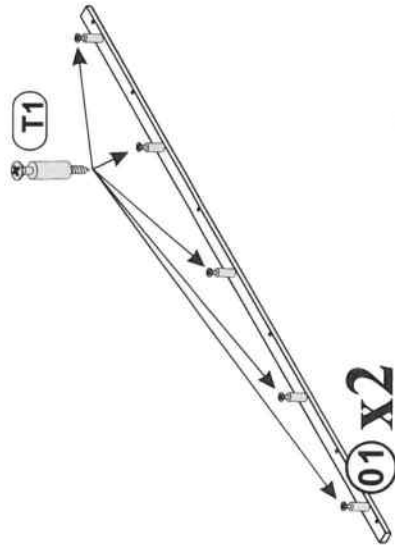

2



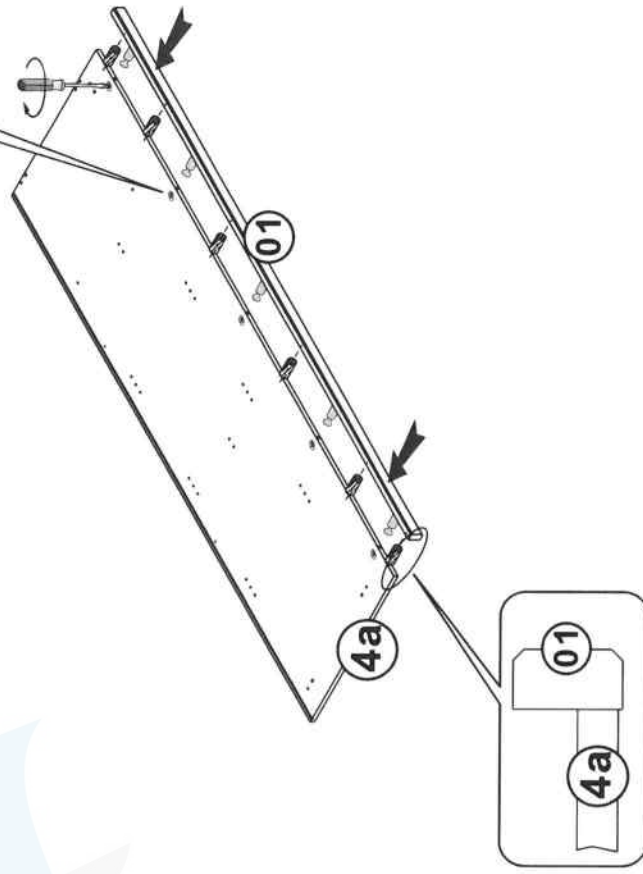
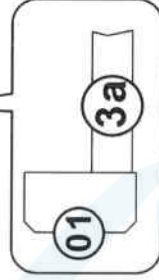
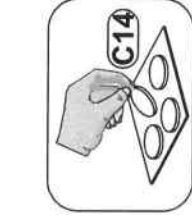
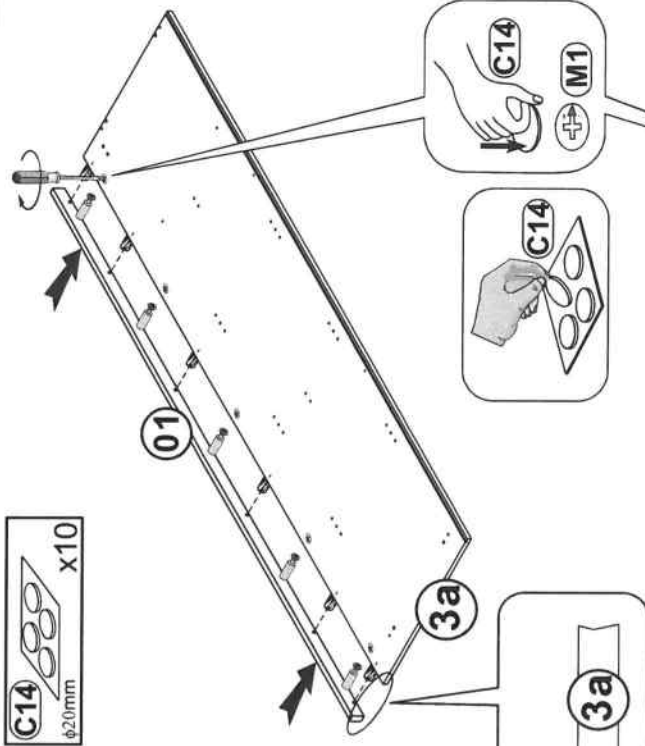



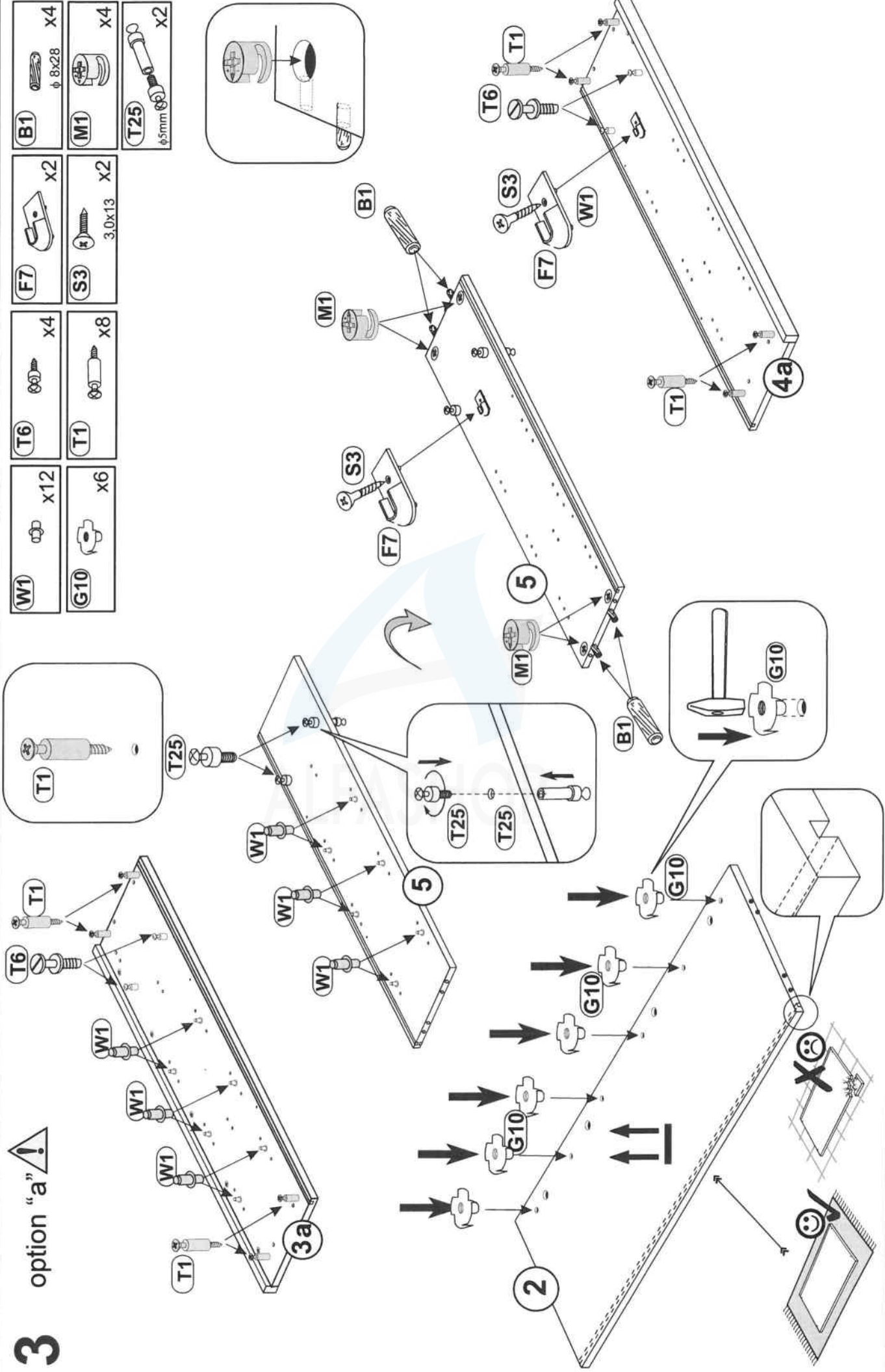

- (C14)  ϕ 20mm x10



ALFAShop





3 option "a" 

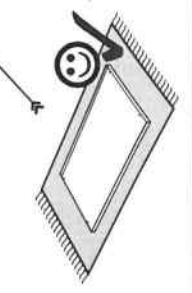
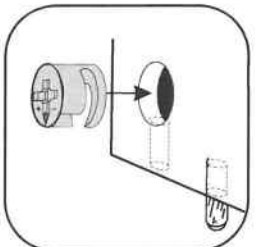

W1  x12	T6  x4	F7  x2	B1  φ 8x28 x4
G10  x6	T1  x8	S3  3.0x13 x2	M1  x4
			T25  φ5mm x2



4

	x3		x4
	x2		
	x6		
	x9		

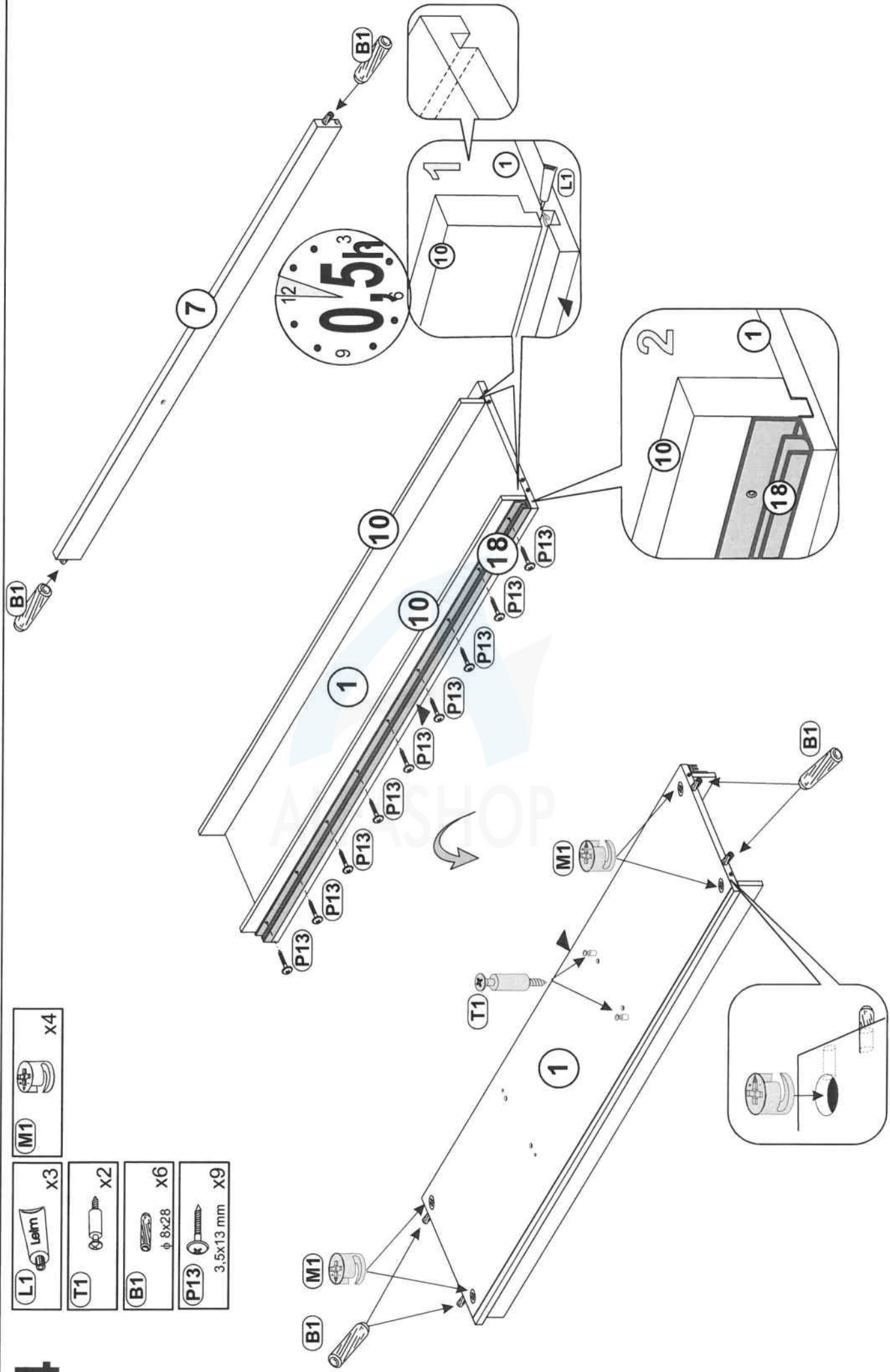

5a

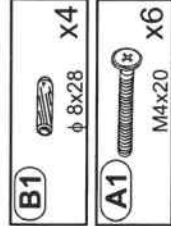
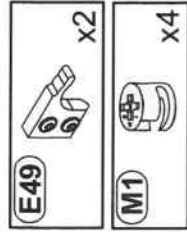

option "c" !

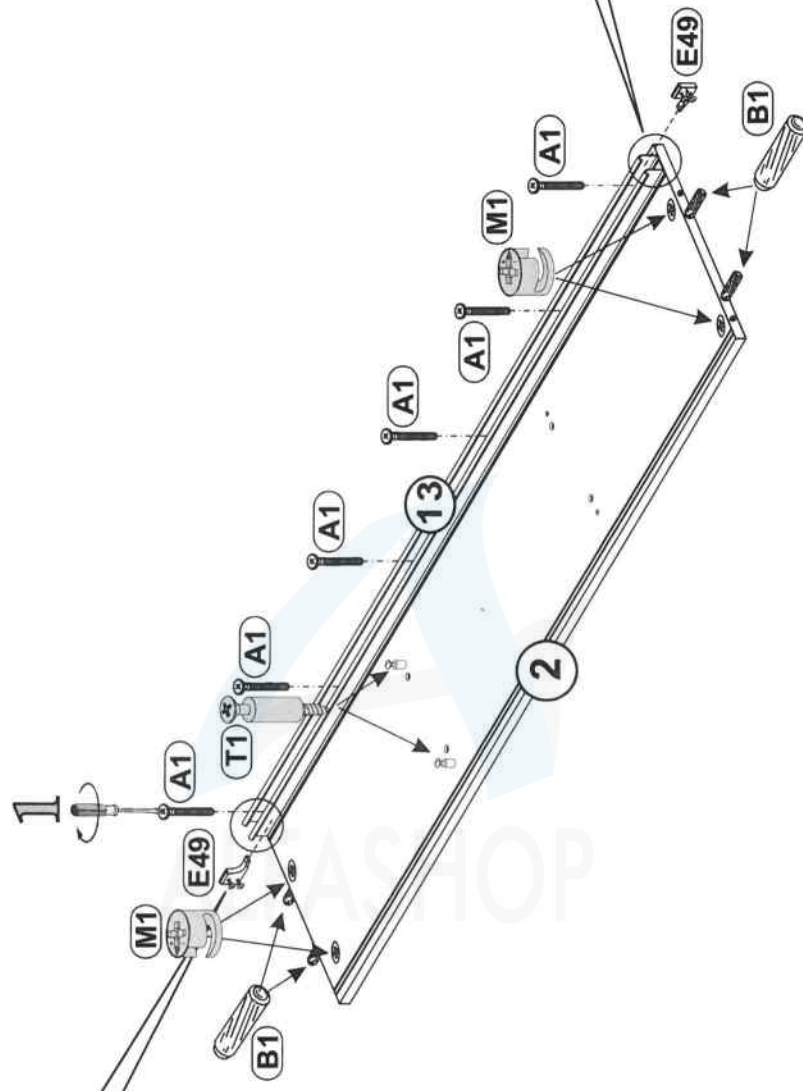
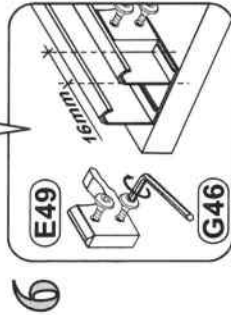
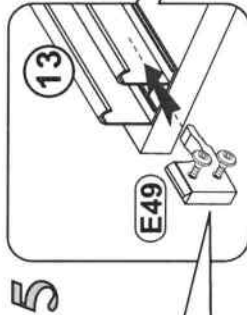
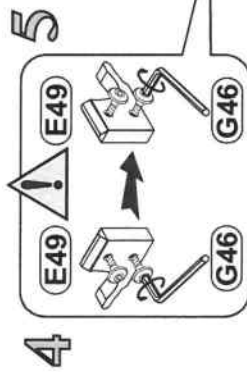

3a

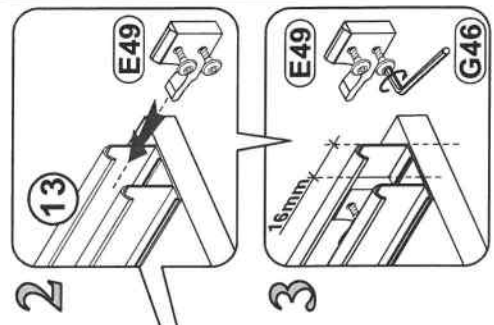
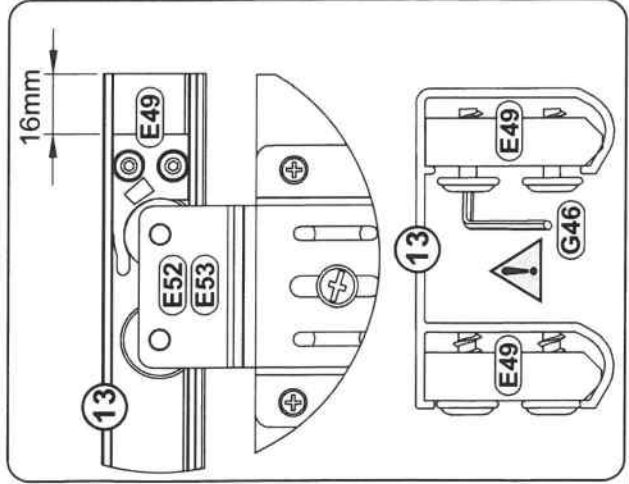

5b

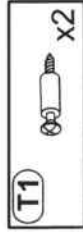
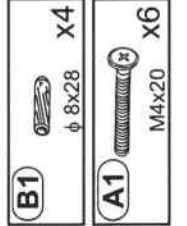
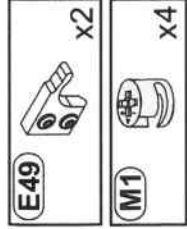



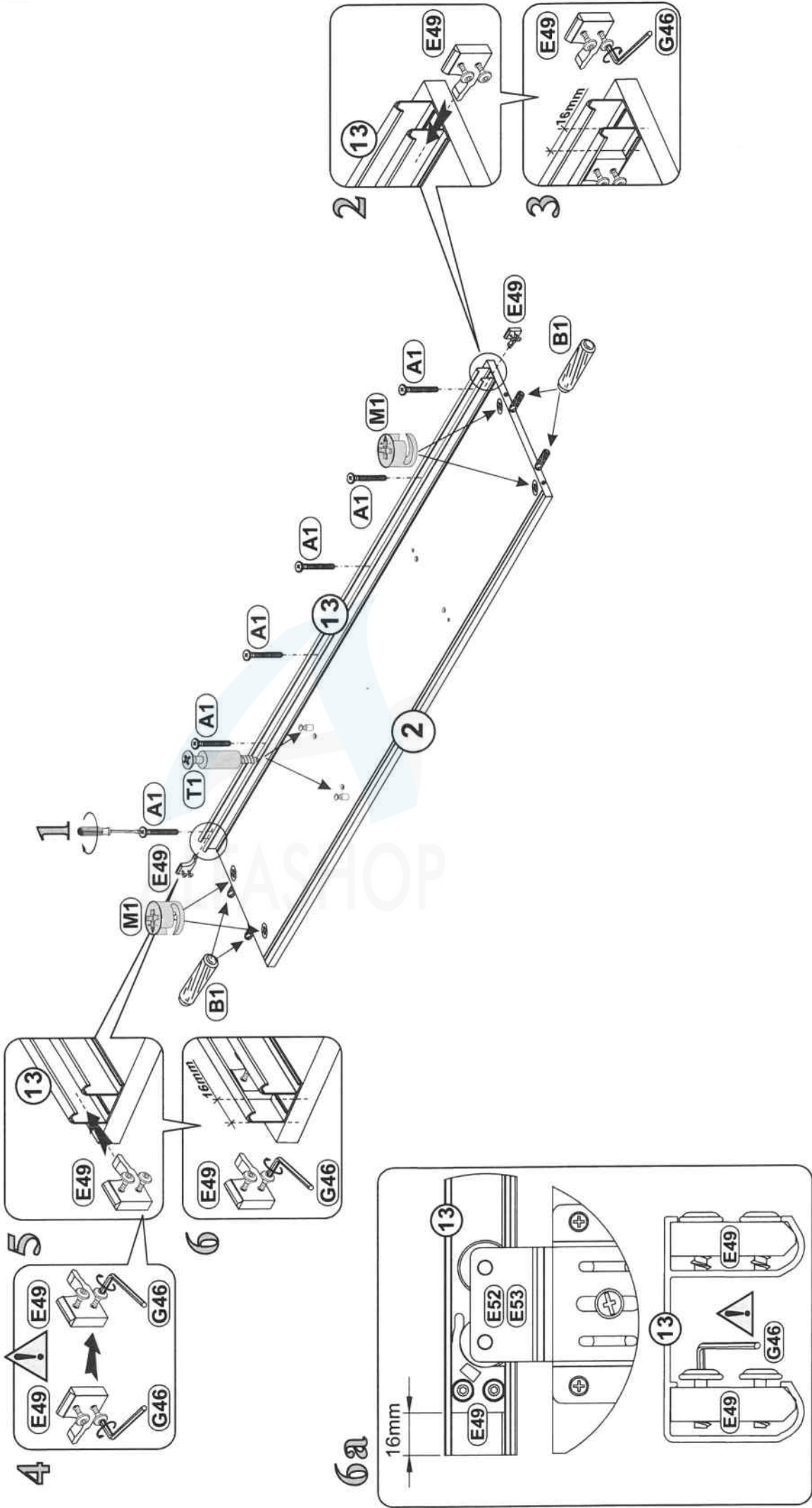

option "d" ⚠

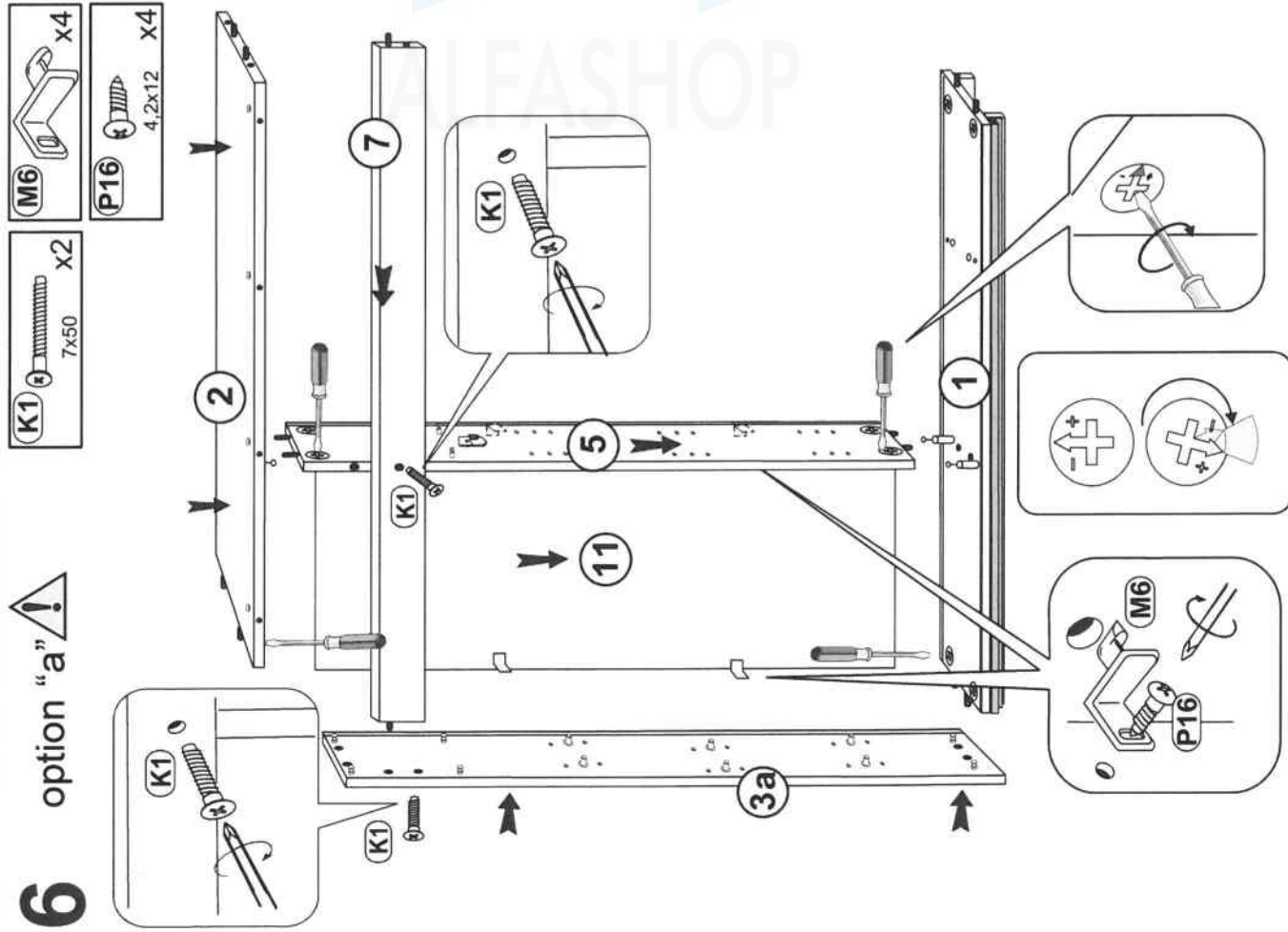

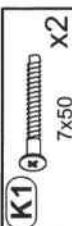

6 option "a" 

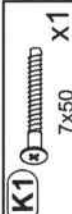



-  K1 7x50 X2
-  M6 X4
-  P16 4,2x12 X4



-  K1 7x50 X1
-  J22 L=2058 mm X1

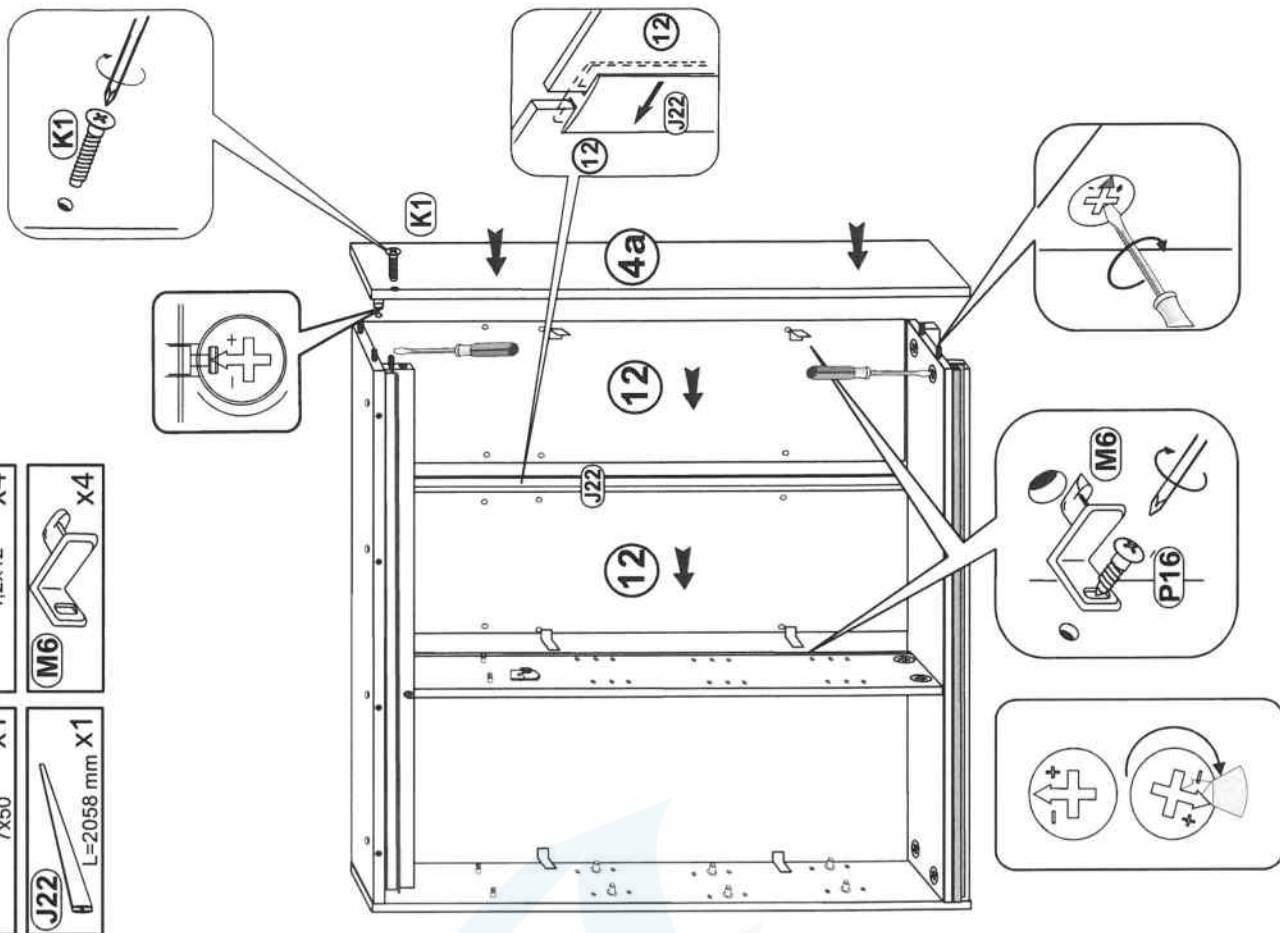

-  P16 4,2x12 X4
-  M6 X4

7

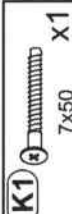

-  P16 4,2x12 X4
-  M6 X4

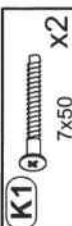
-  K1 7x50 X1
-  J22 L=2058 mm X1

-  K1 7x50 X2
-  M6 X4
-  P16 4,2x12 X4

8

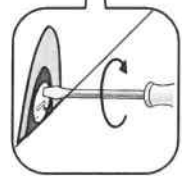
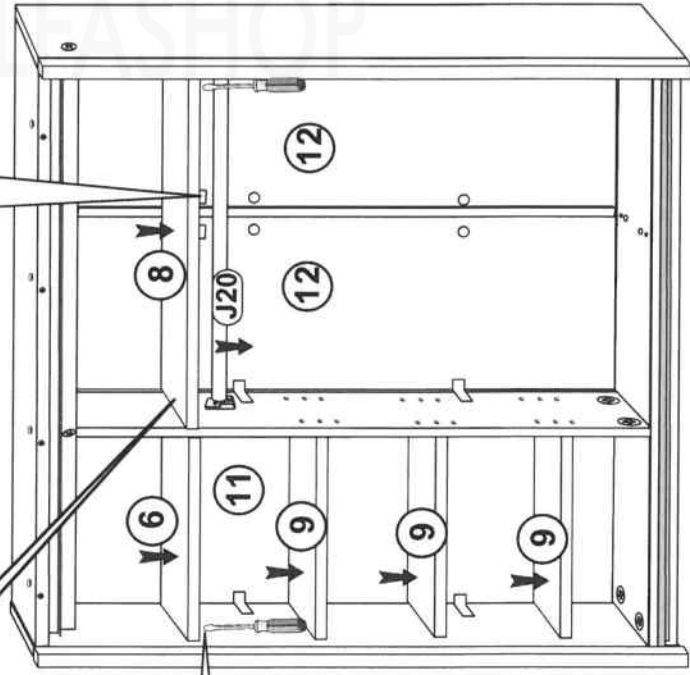
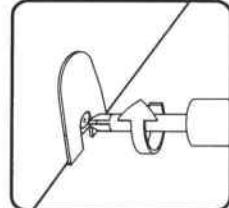
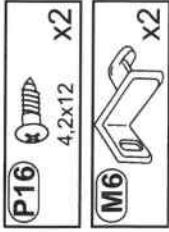

9

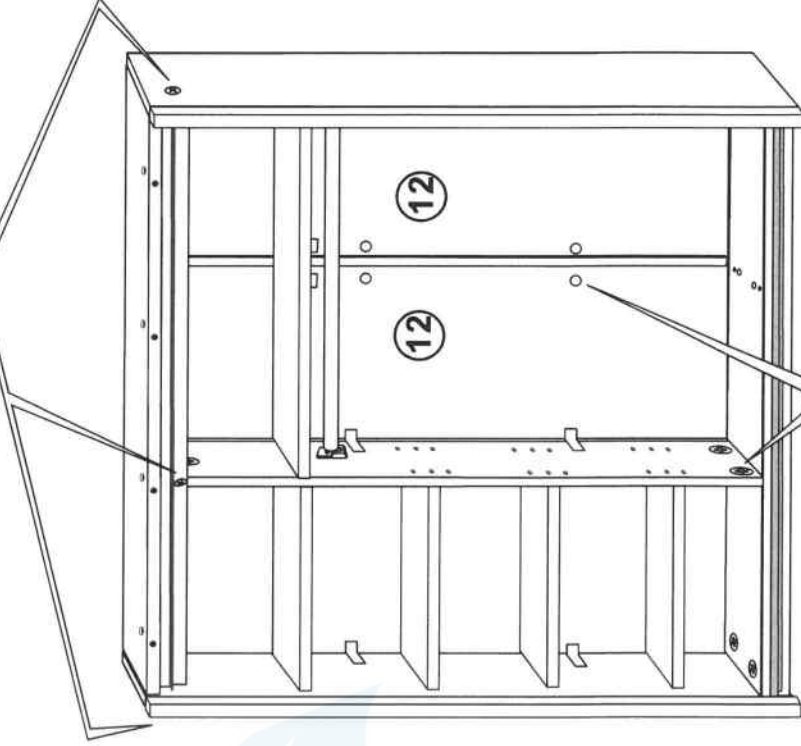

10

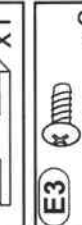
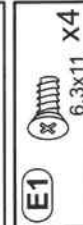
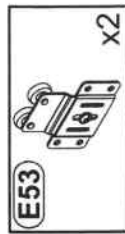

option "c" ⚠

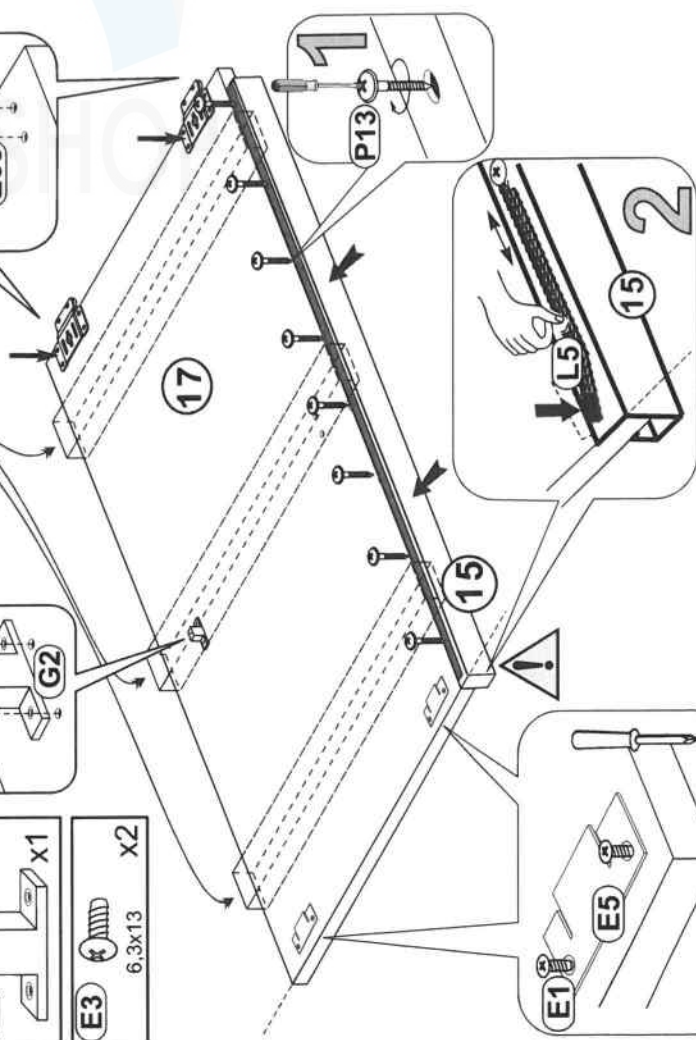
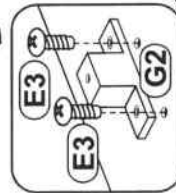
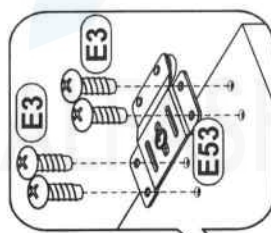
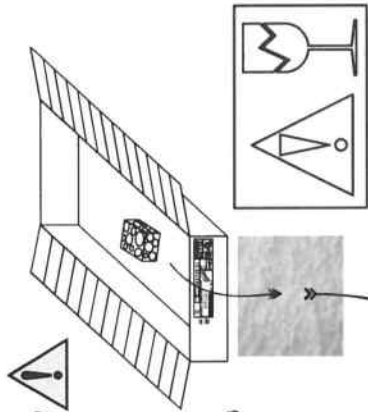
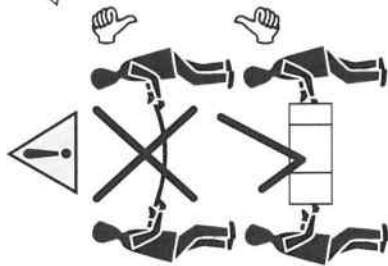

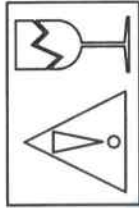

11



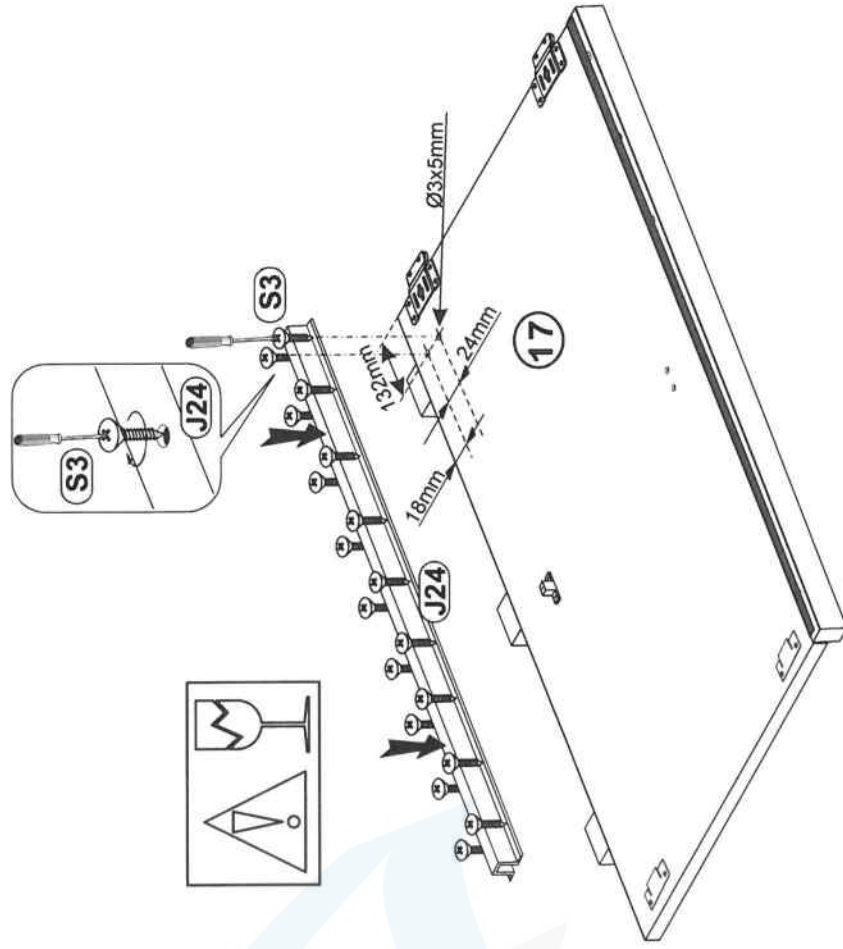

option "c" ⚠

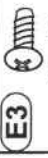

10

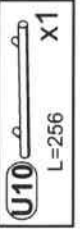
- E52**  x2
- E3**  6.3x13 x8
- E5**  x2
- E1**  6.3x11 x4

- U10**  L=256 x1
- A5**  M4x40 x2

option "c"  !

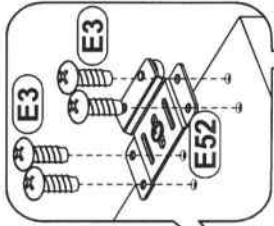
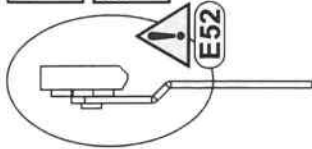

16

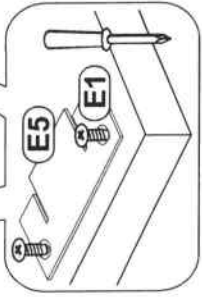
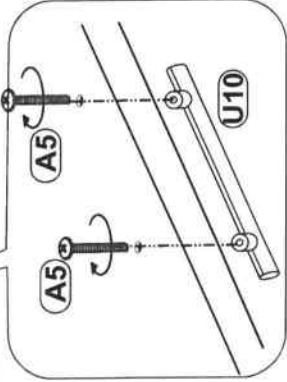
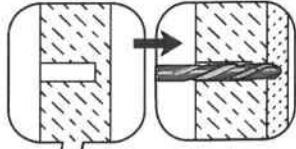
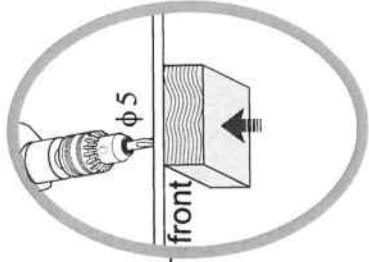

ALFASHOP

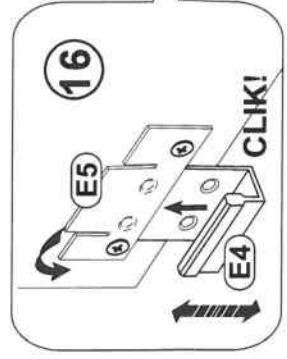
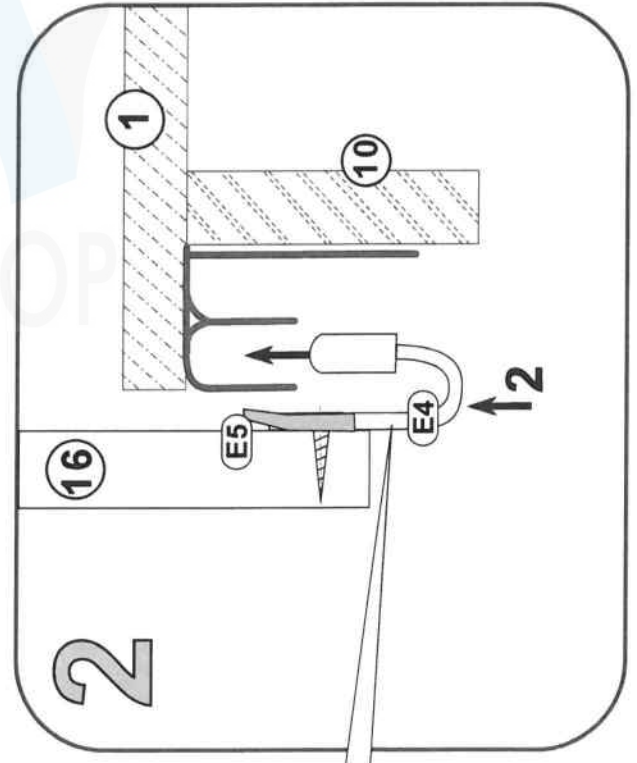
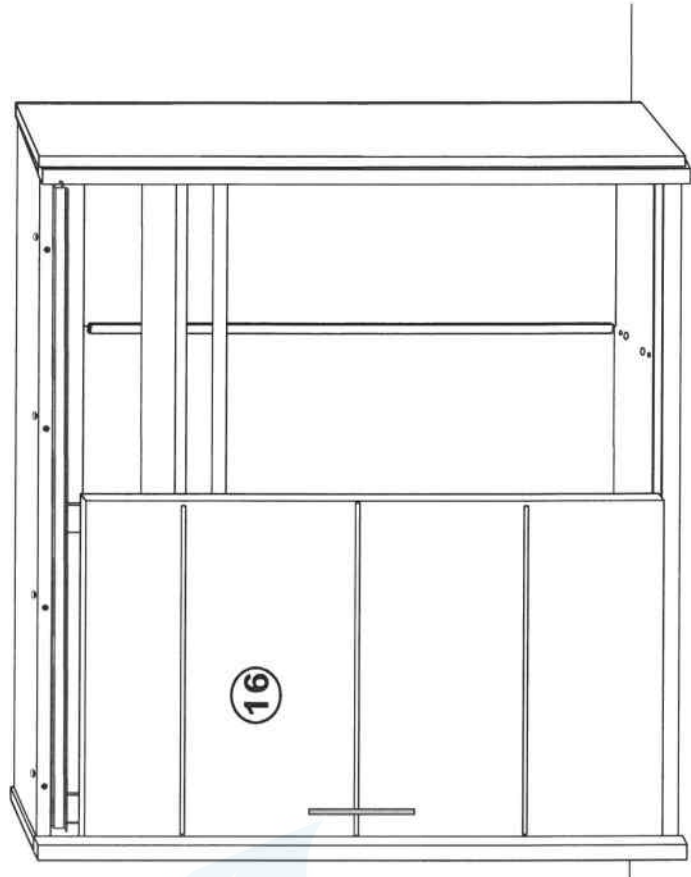
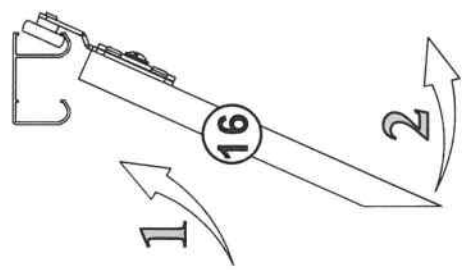
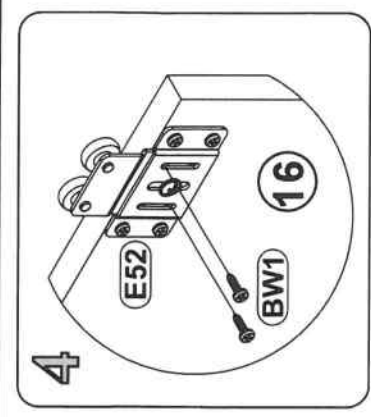
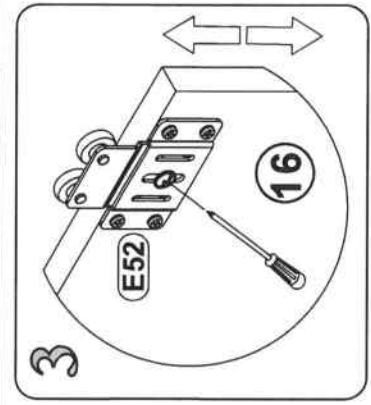
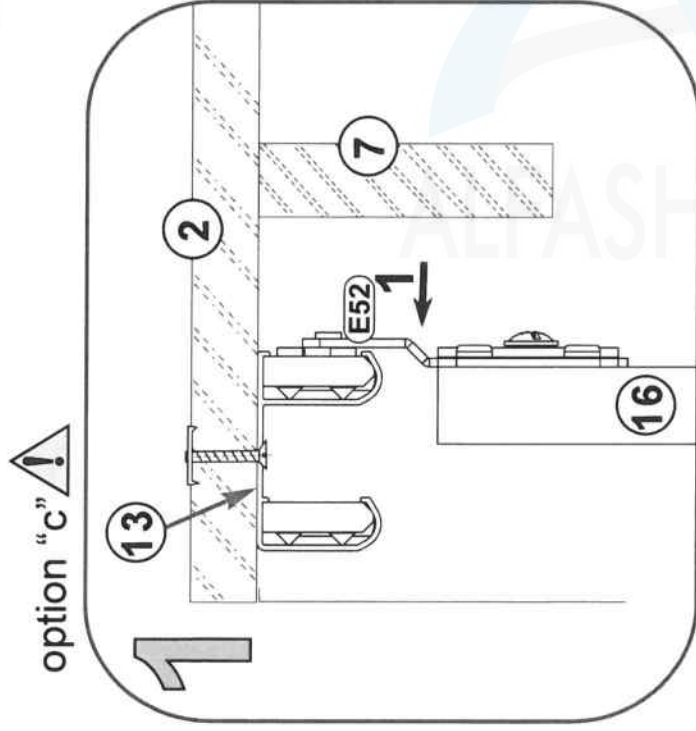

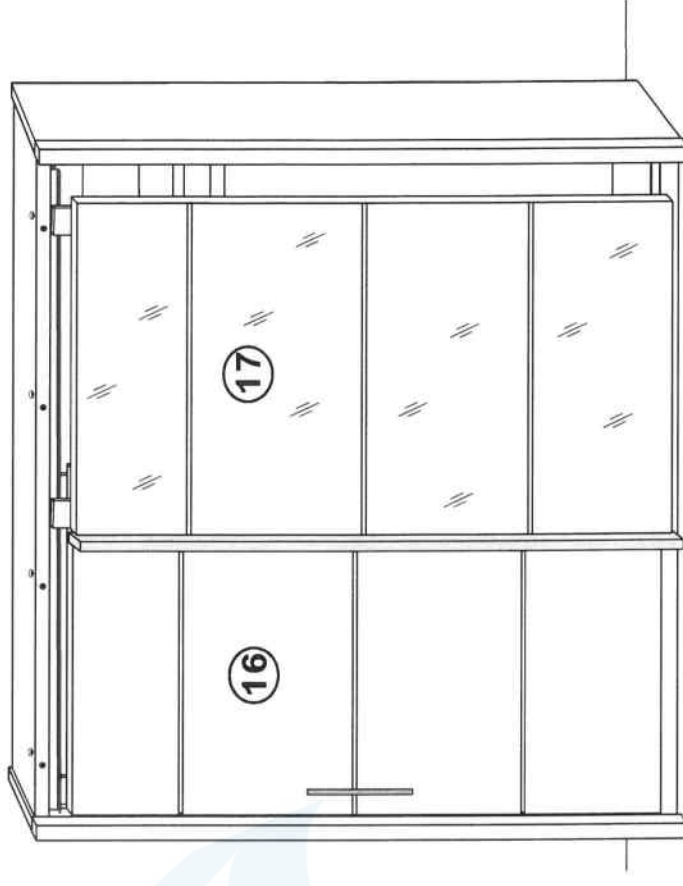
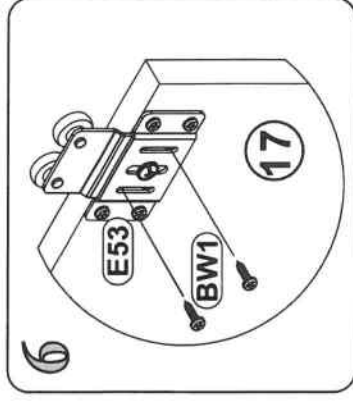
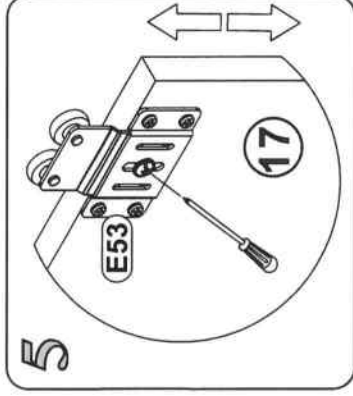
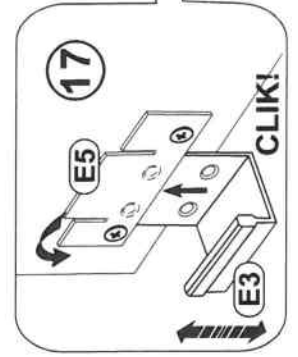
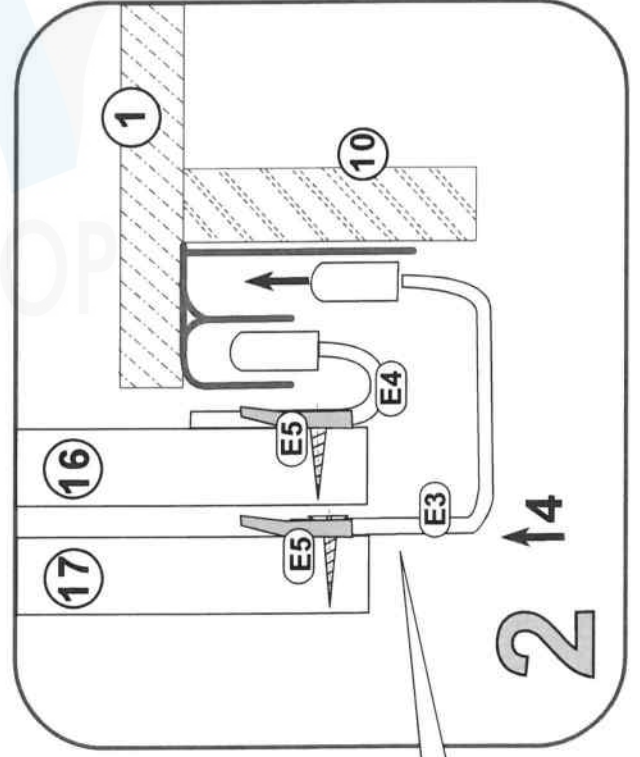
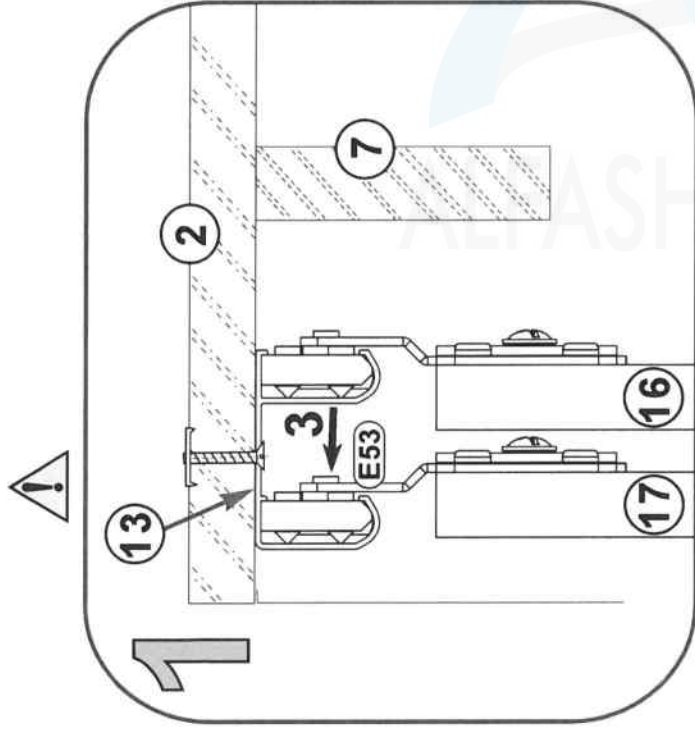
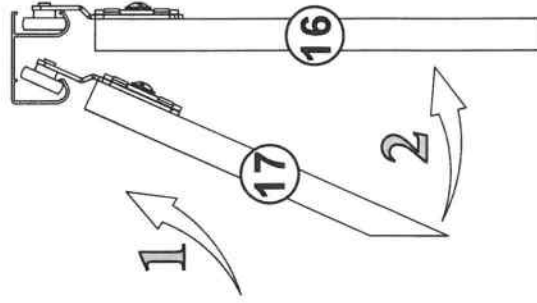
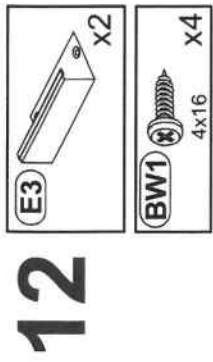

13

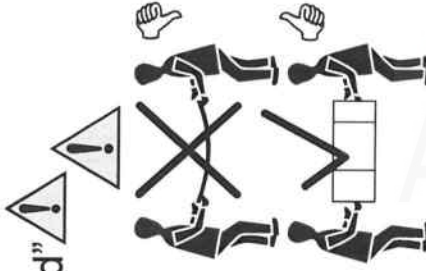
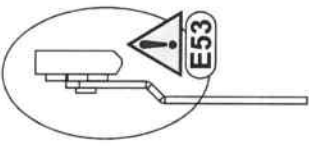
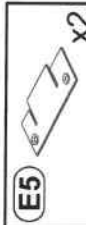

option "d"

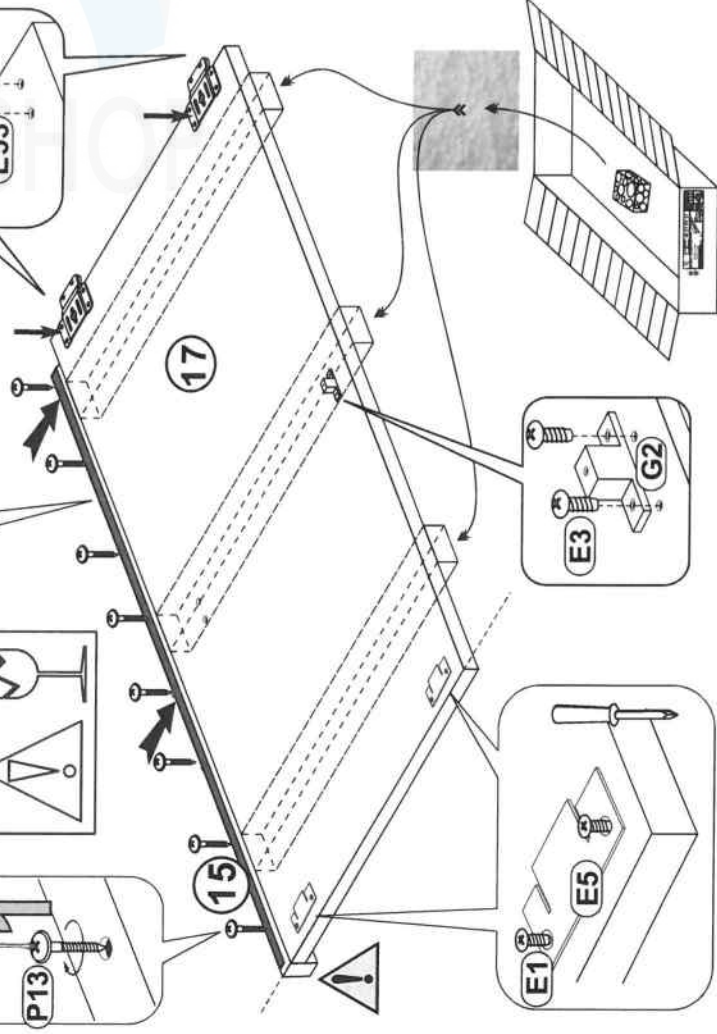
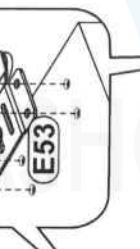
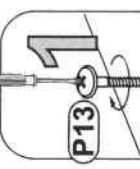
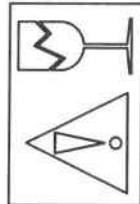
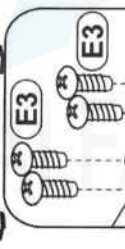
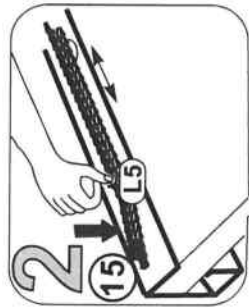





14

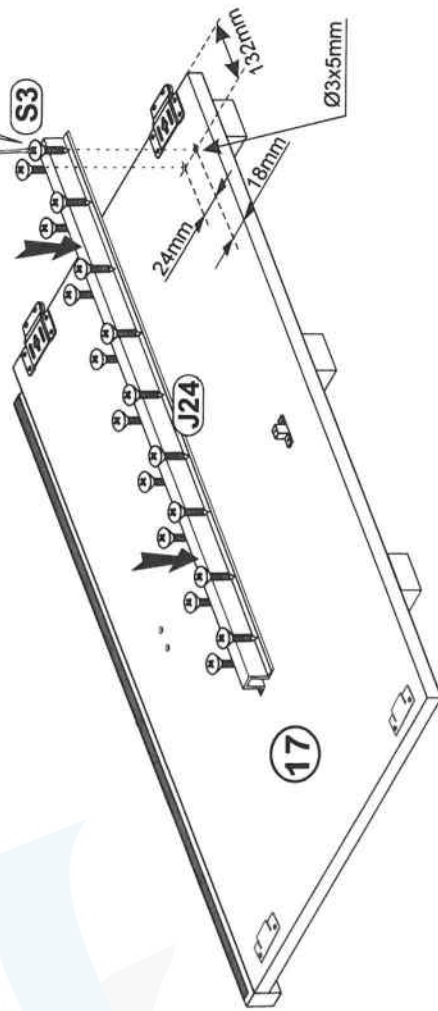
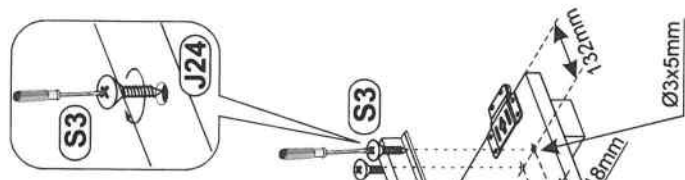
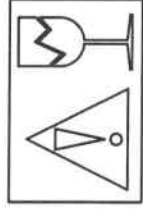



option "d"

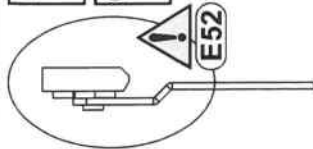

15

- (E52)**  x2
- (E3)**  6.3x13 x8
- (E5)**  x2
- (E1)**  6.3x11 x4



- (U10)**  L=256 x1
- (A5)**  M4x40 x2

option "d" 

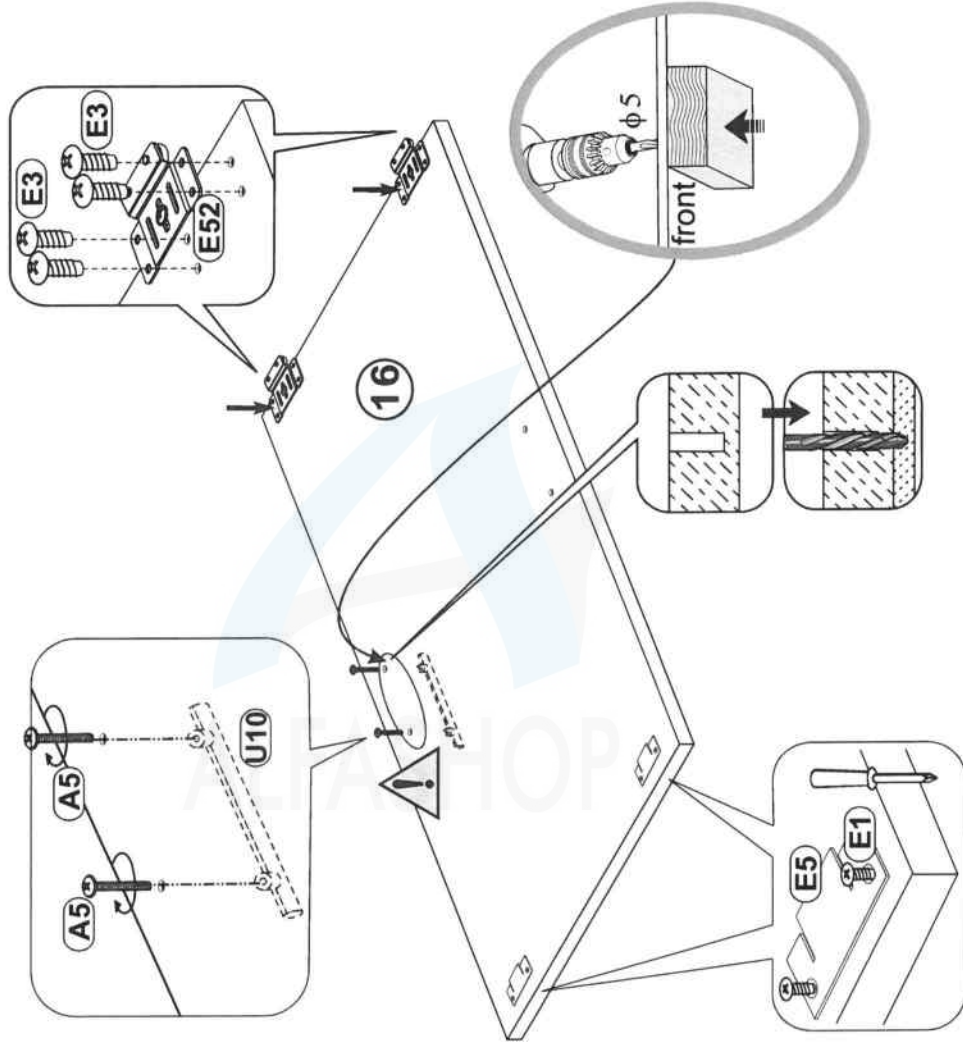
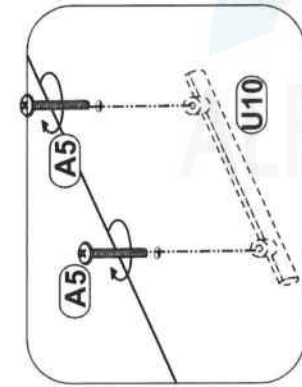

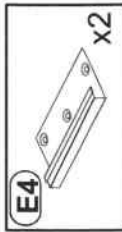
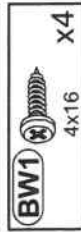
- 16**  x2
-  4x16 x4

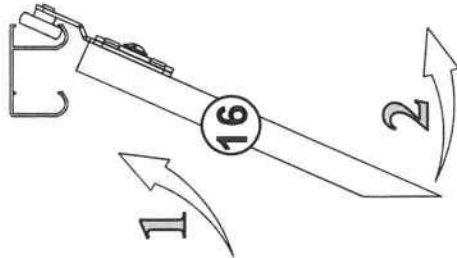

option "d" 

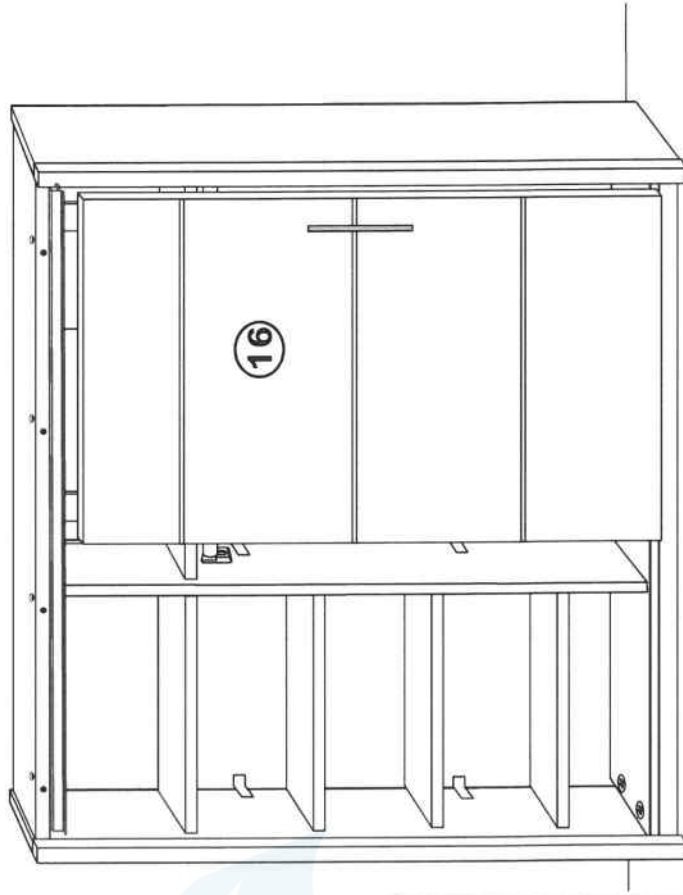
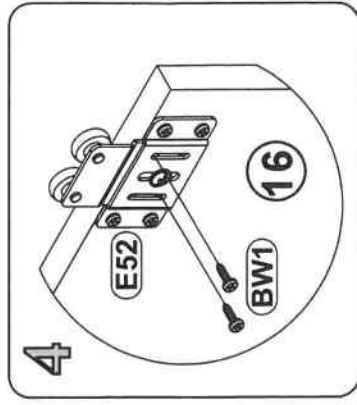
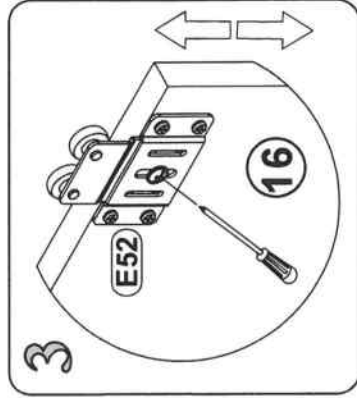
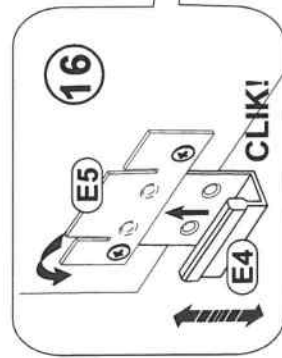
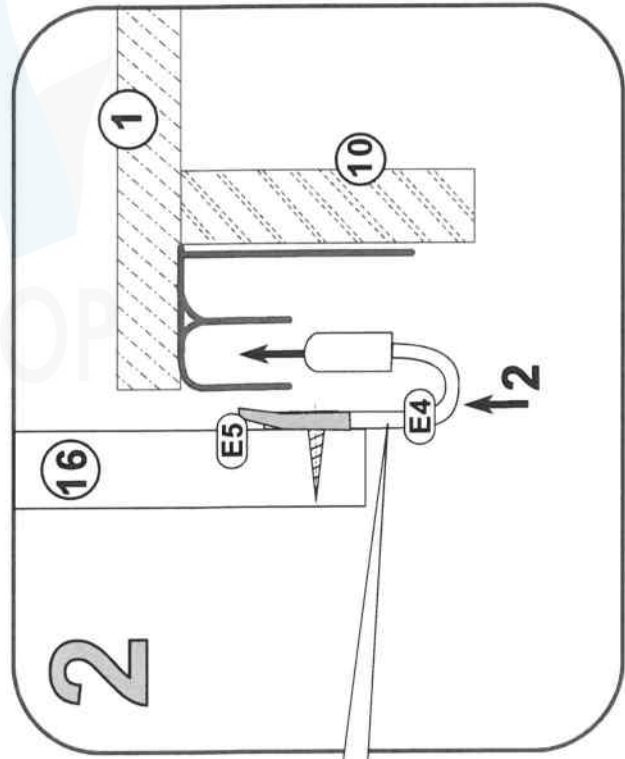
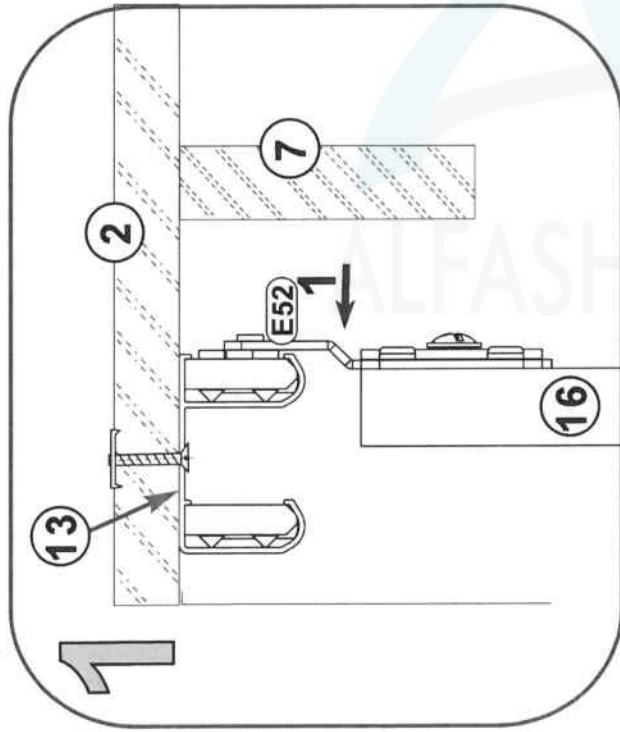

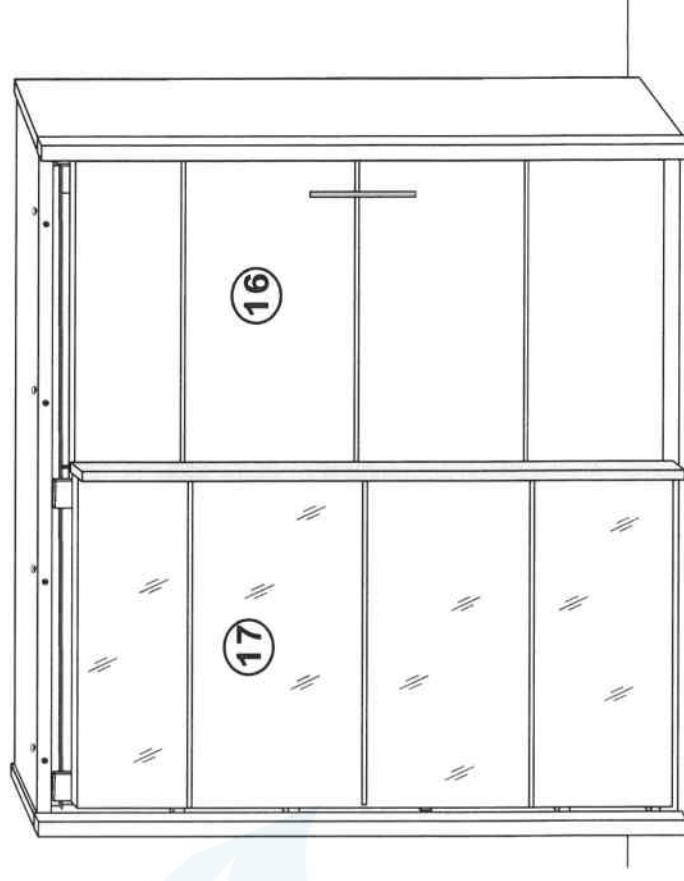
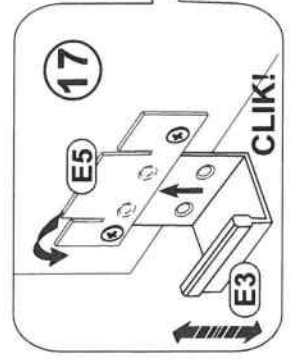
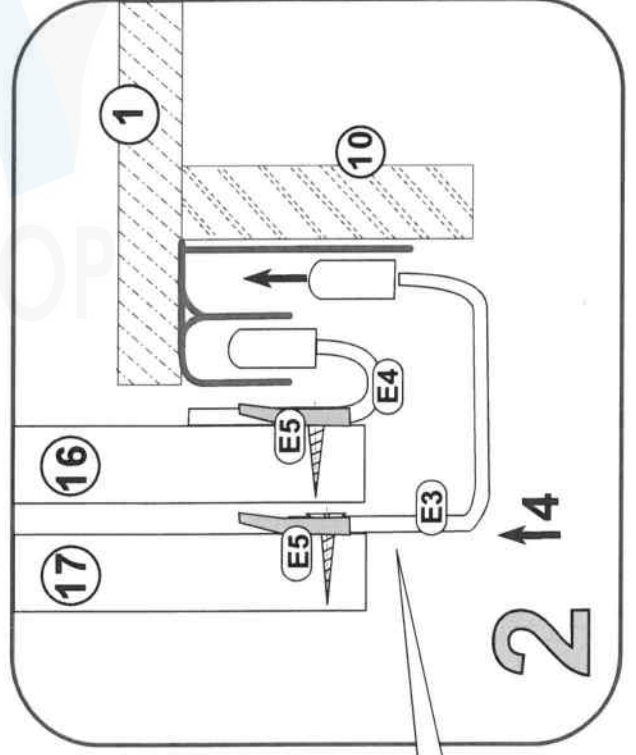
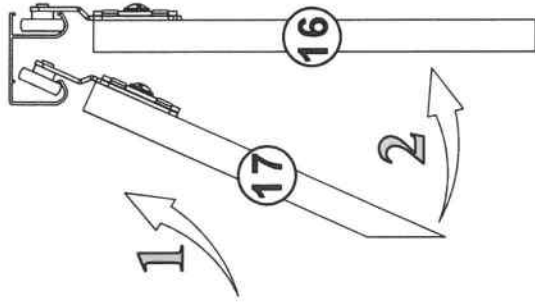
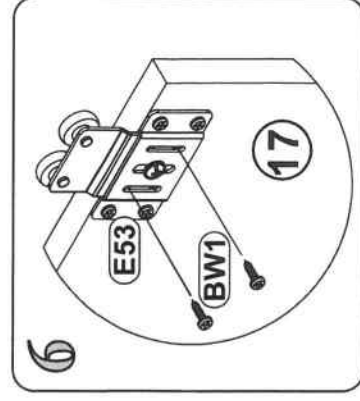
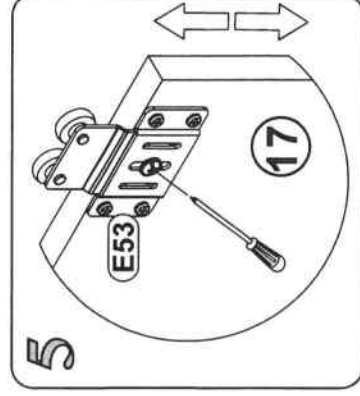
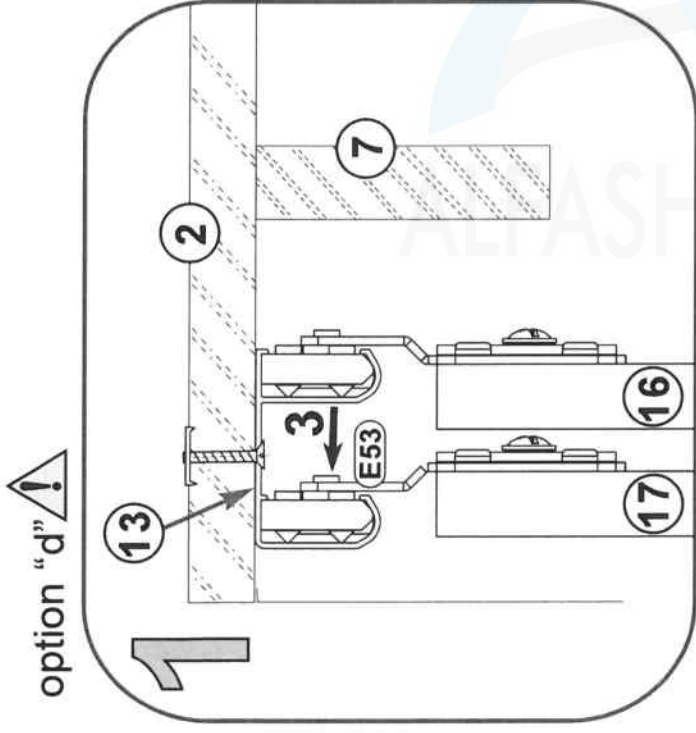
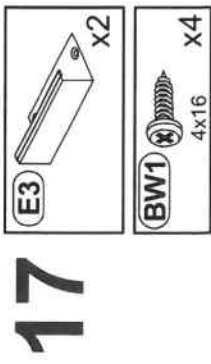



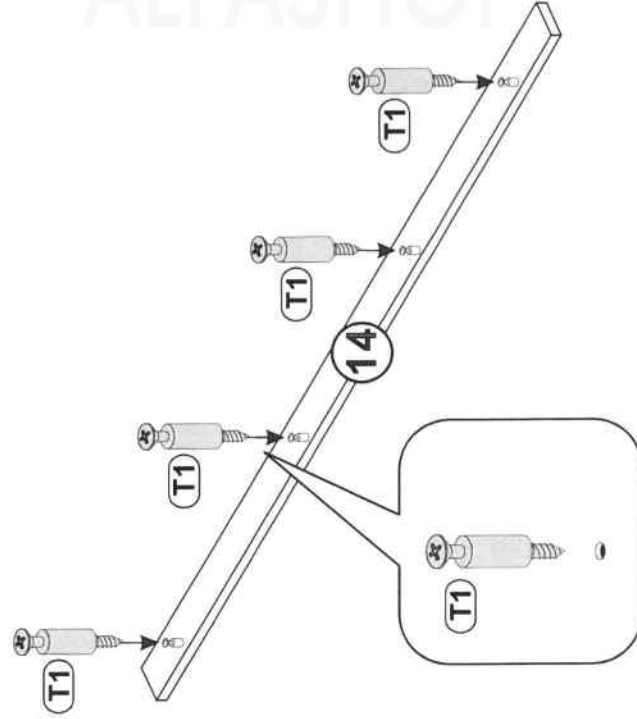
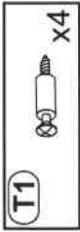

18

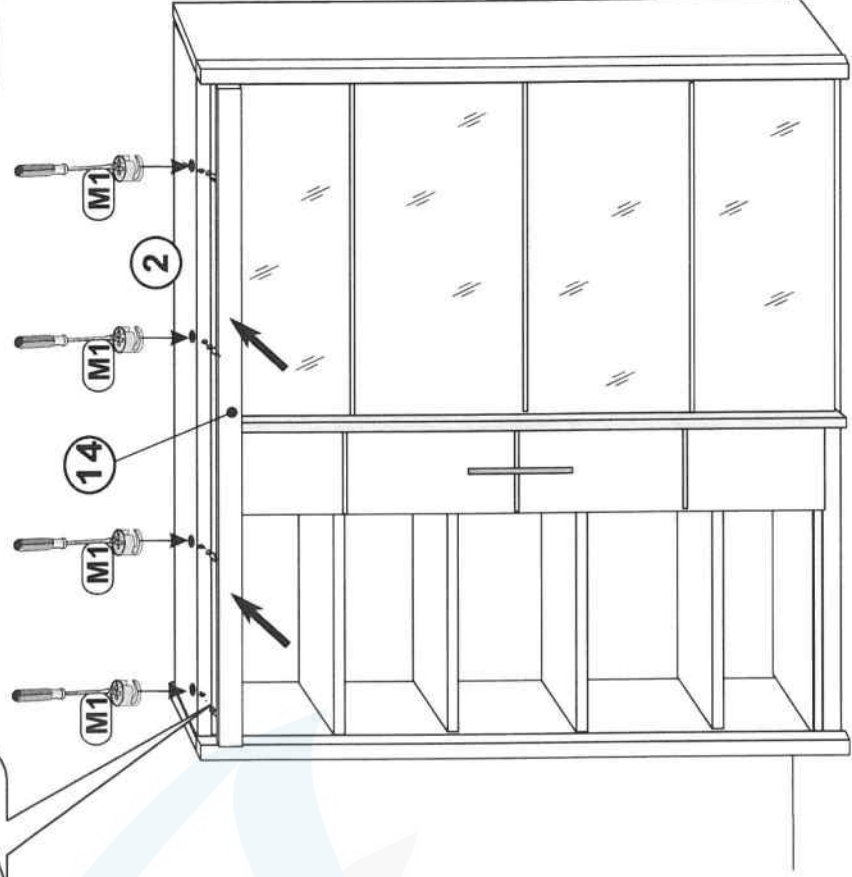
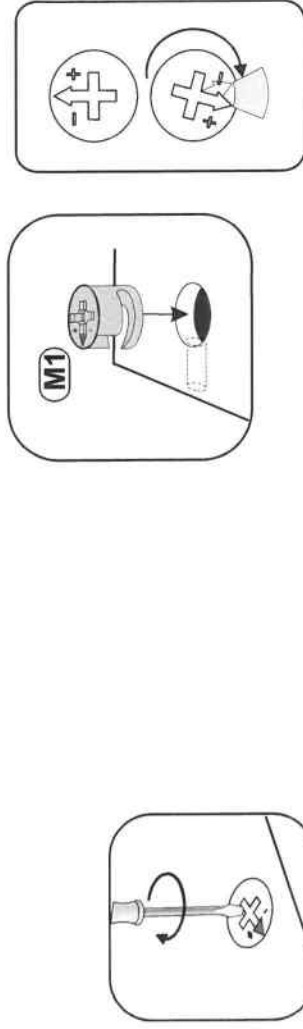

19



20

- L4**  x3
- J11**  x2
- P13**  3.5x13 mm x4

