

option "a"

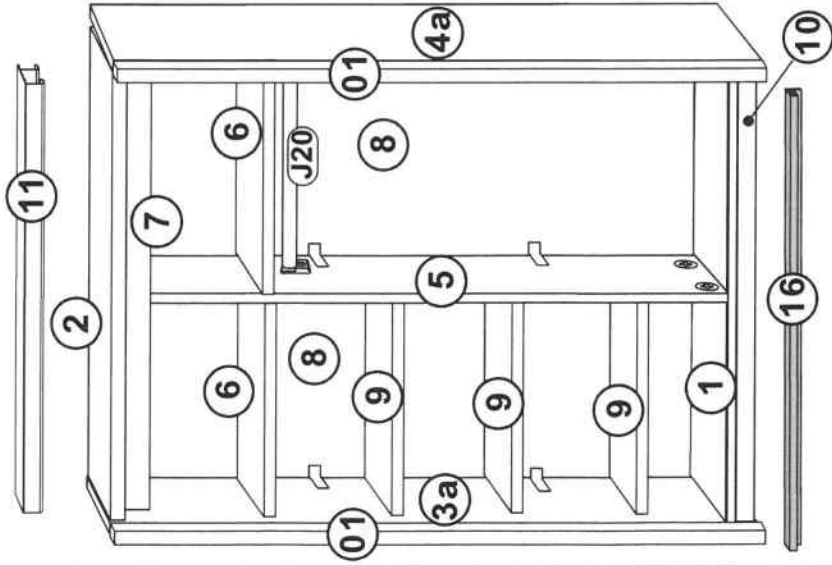

option "b"

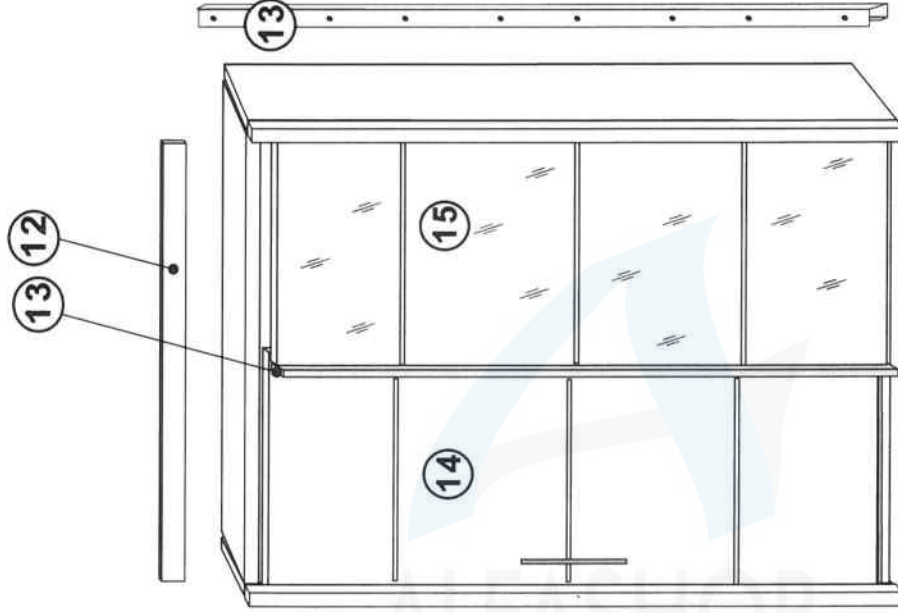
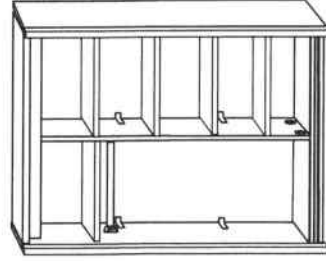

option "c"

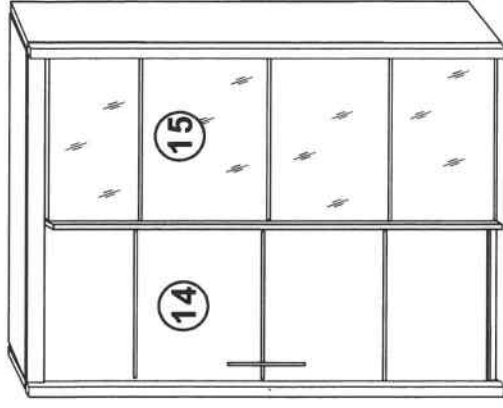



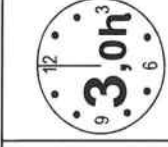
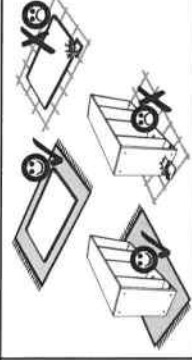
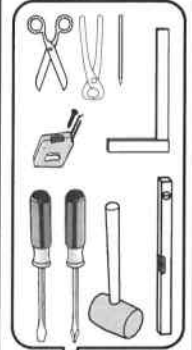
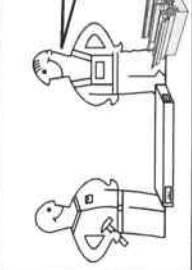
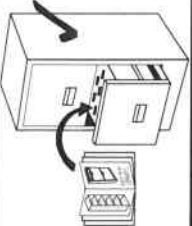
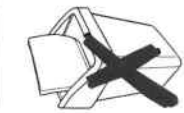
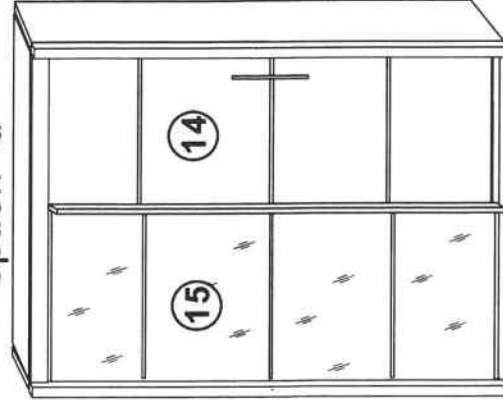



option "d"







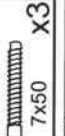



1

L1		x3
-----------	---	----

2

B1		φ 8x28	x26
T6			x4
T25		φ5mm	x2
M1			x26
T1			x26
K1		7x50	x3
M6			x8
P16		4,2x12	x8



3

W1		x12	
P13		3,5x13 mm	x5
A1		M4x20	x4
G10			x4
E49			x2
G2			x1
E3		6,3x13	x2
C14		φ20mm	x25
G46		S 2.5	x1

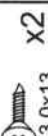

4

F7		x2	
S3		3,0x13	x2



5

E52		x2	
E3		6,3x13	x8
BW1		4x16	x4



6

E53		x2	
E3		6,3x13	x8
BW1		4x16	x4



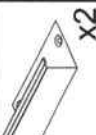
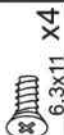

7

E4		x2	
E1		6,3x11	x4
E5			x2

8

E3		x2	
E1		6,3x11	x4
E5			x2

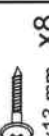
9



U10		L=256	x1
A5		M4x40	x2
P13		3,5x13 mm	x8
L4			x3
L5			x1

J20





L=570 mm x1

10

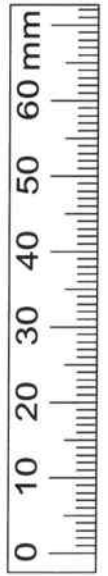
J11		x2	
P13		3,5x13 mm	x4



- B1**  ϕ 8x28 X12
- M1**  X10
- T1**  X10

1

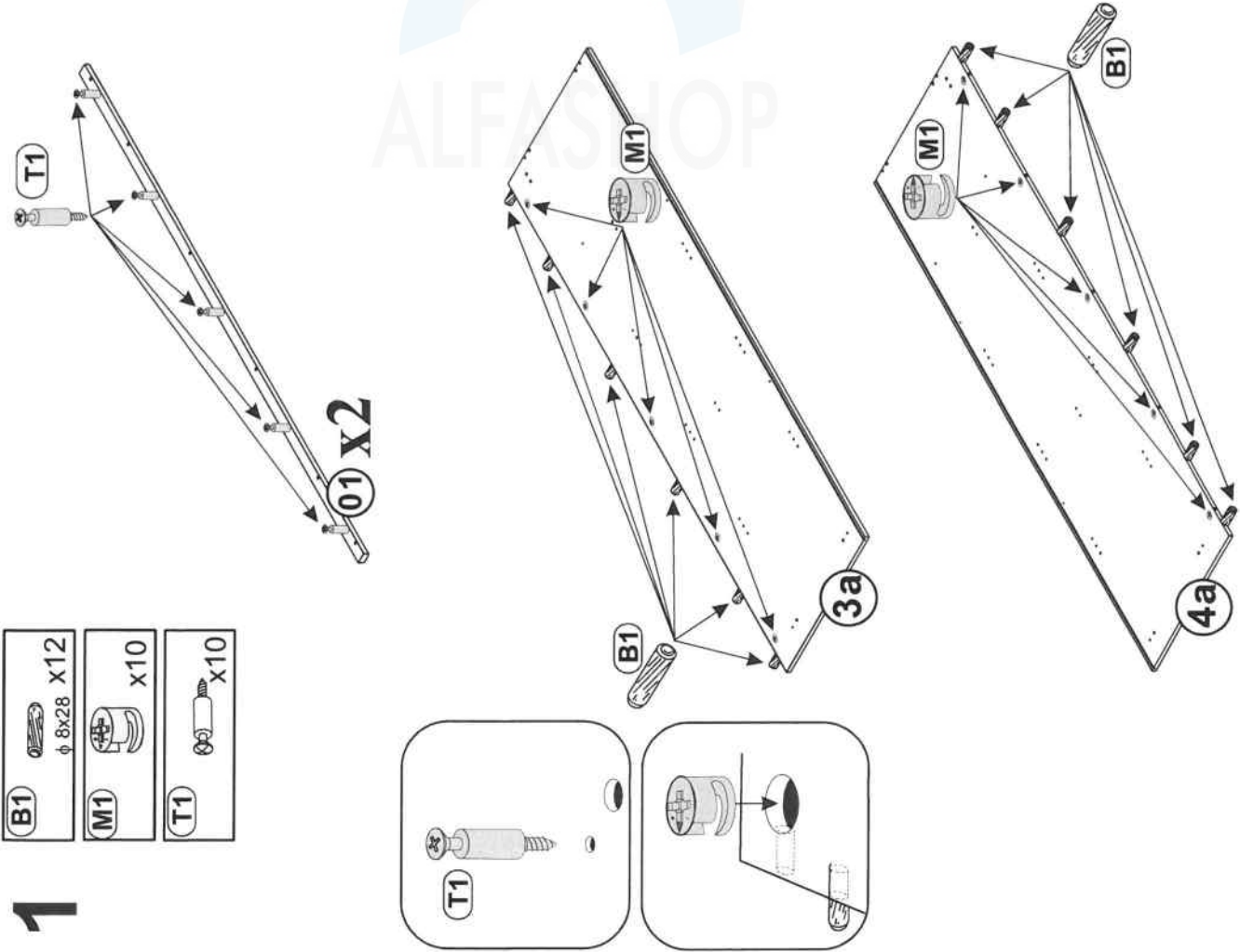

- C14**  ϕ 20mm X10



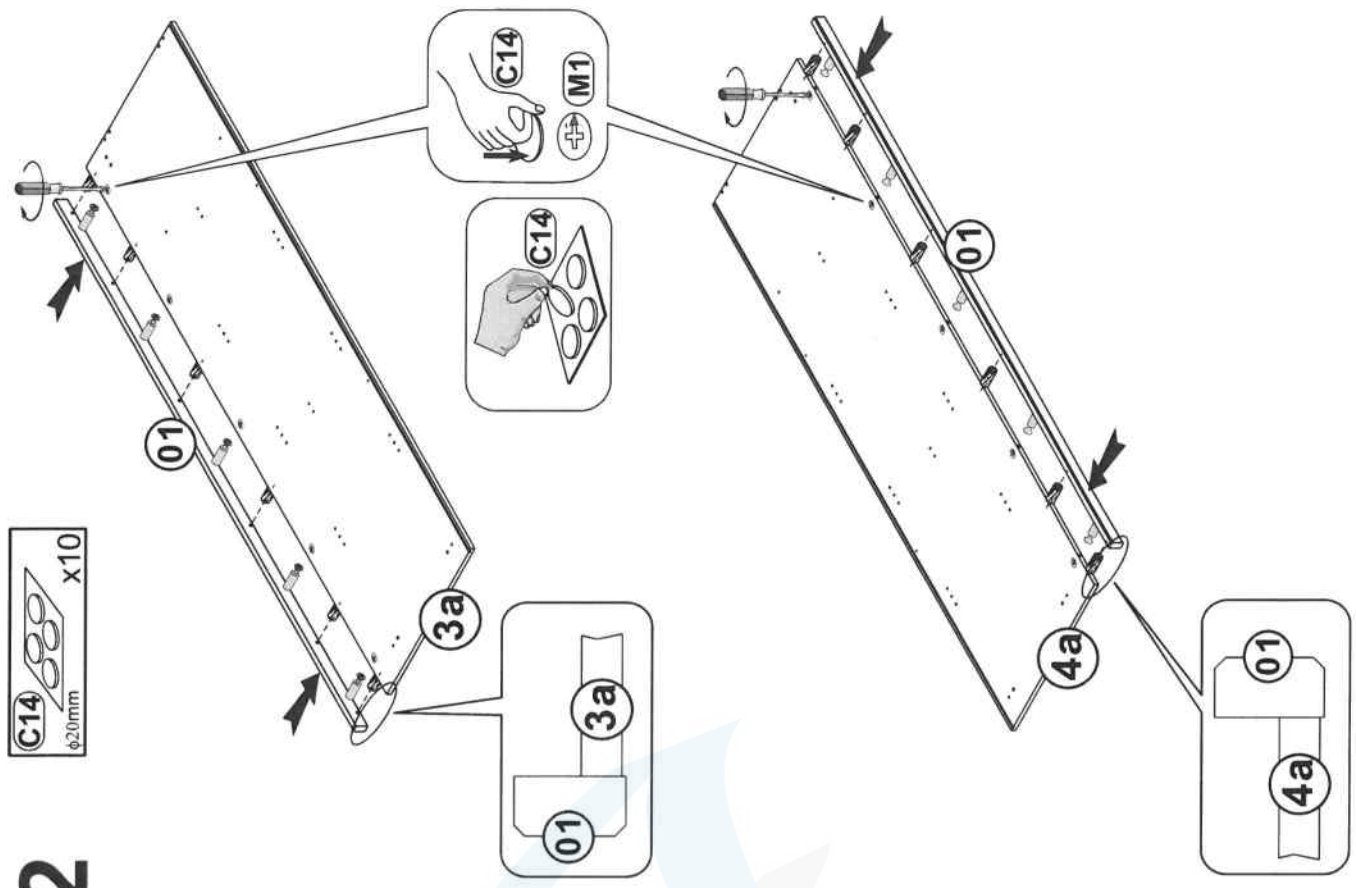

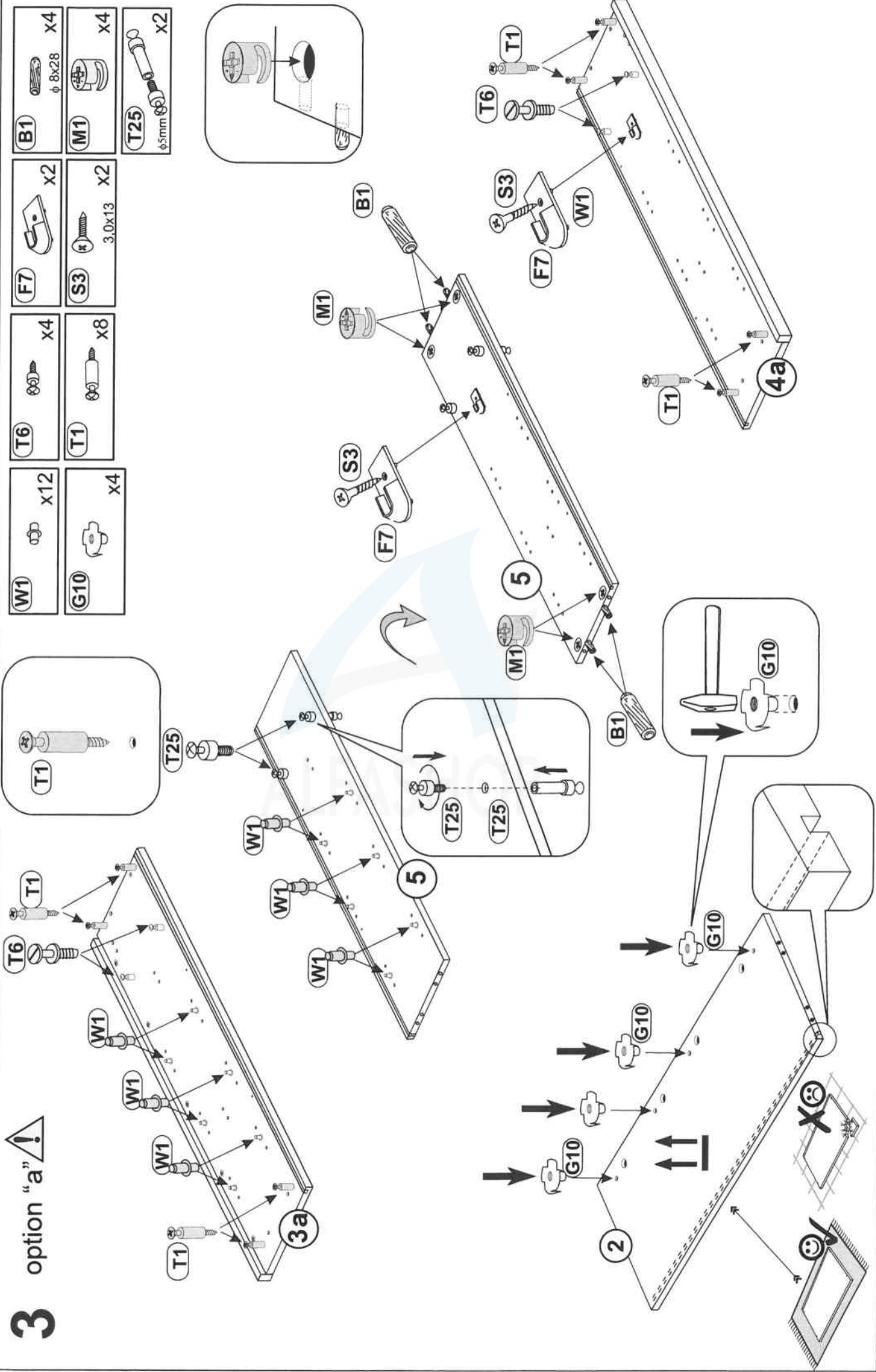

2



3 option "a" 



4

L1 	x3	M1 	x4
T1 	x2	B1 	x6
P13 	x5	B1 	x6
		P13 	x5

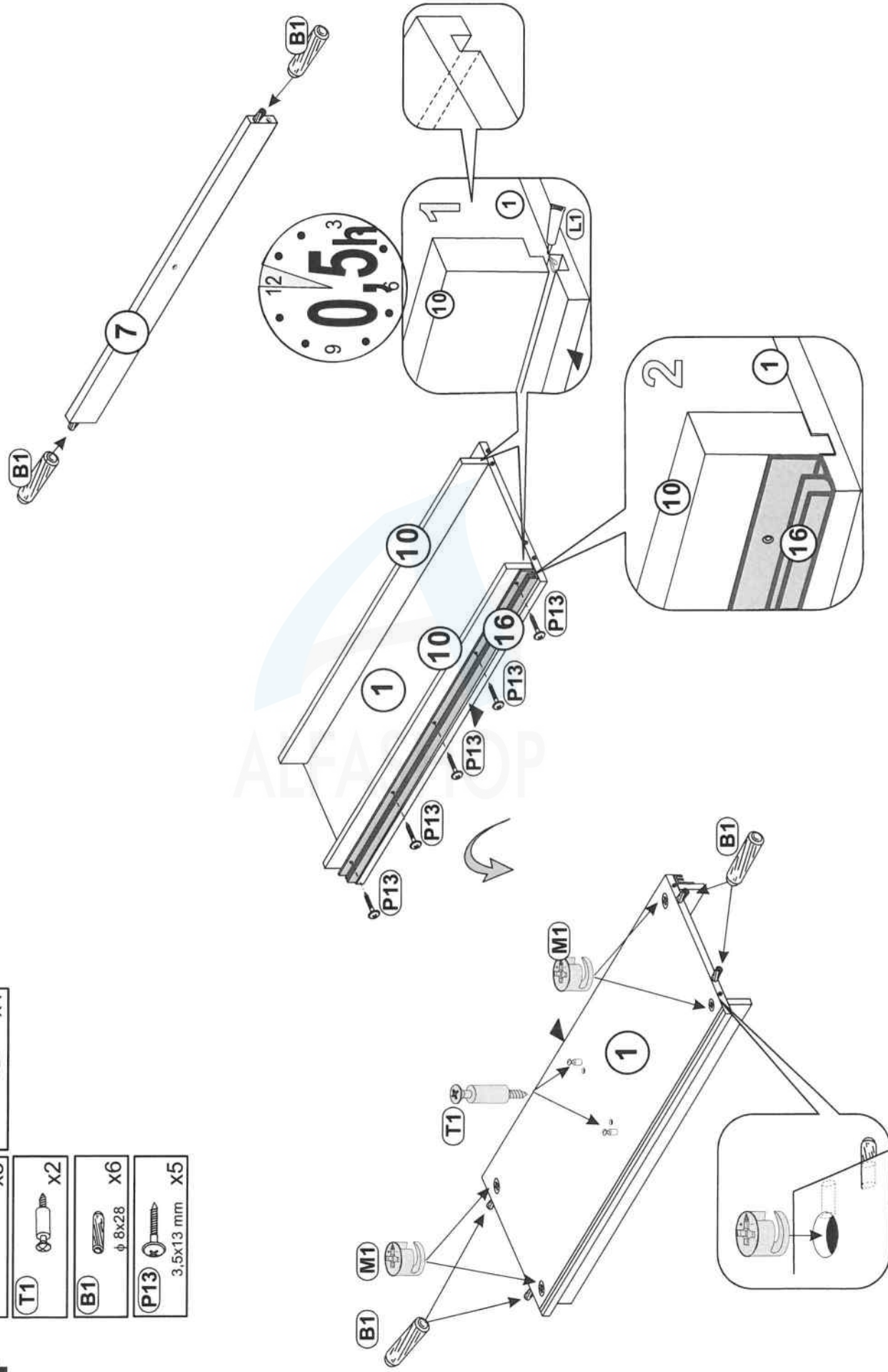

5a

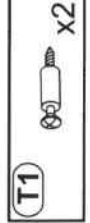
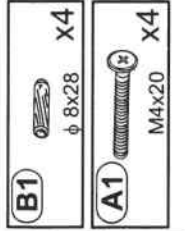
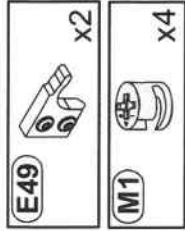

option "c"

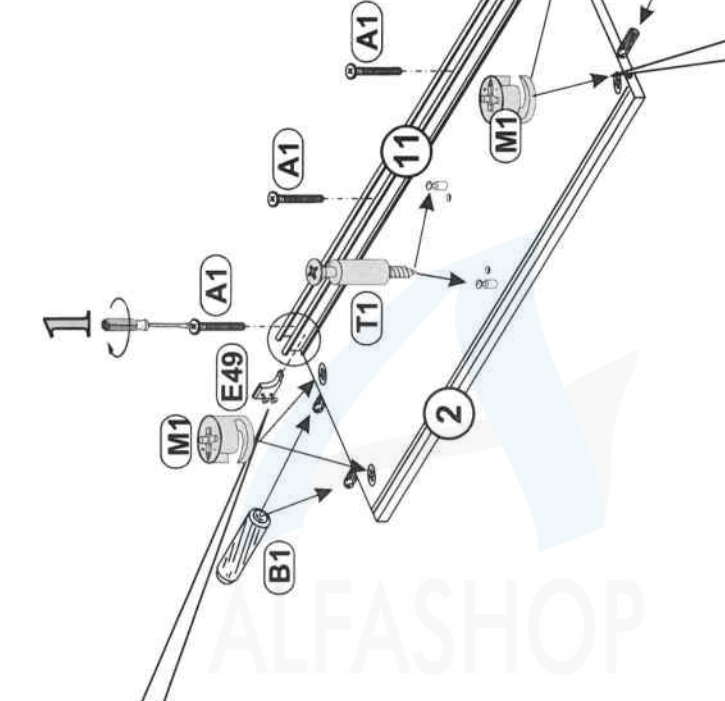
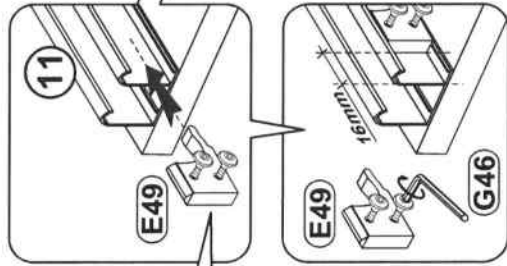
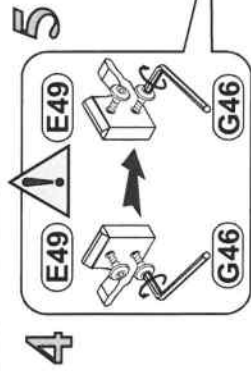

3a

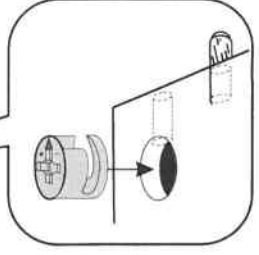
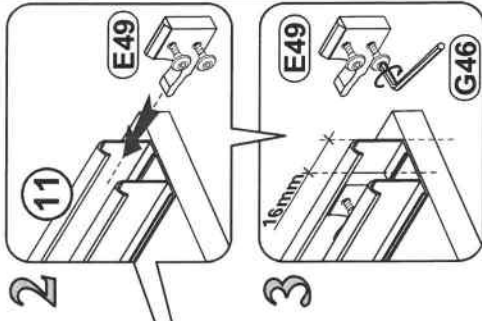
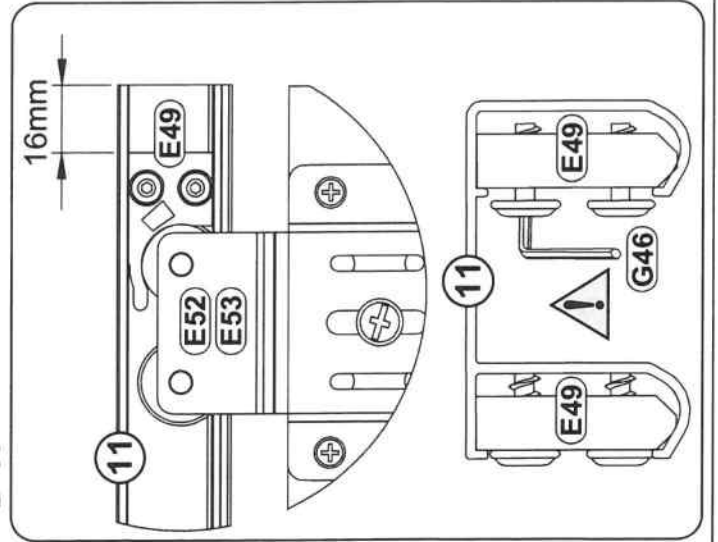

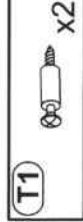
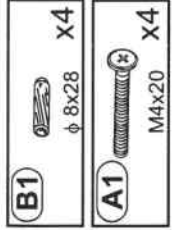
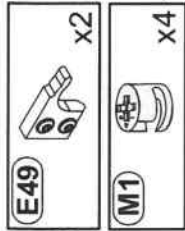

5b

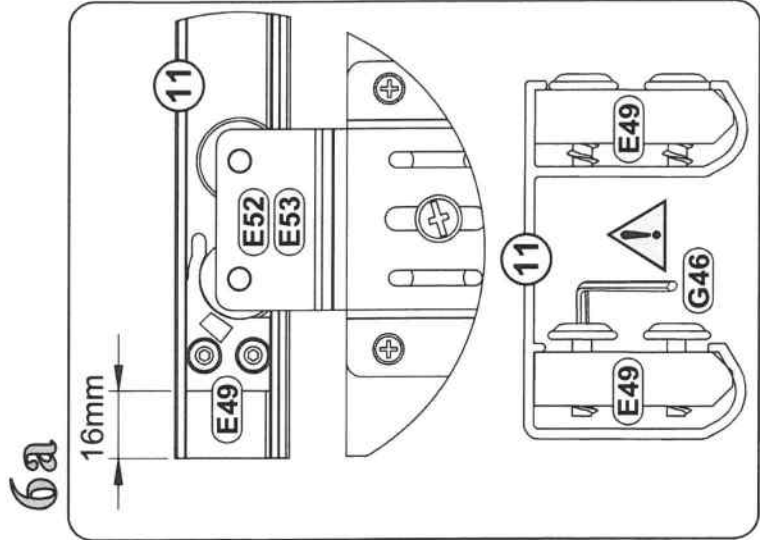
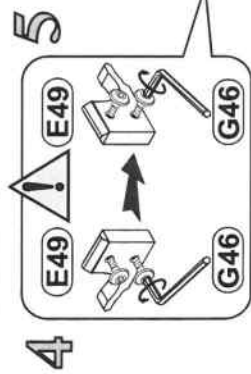
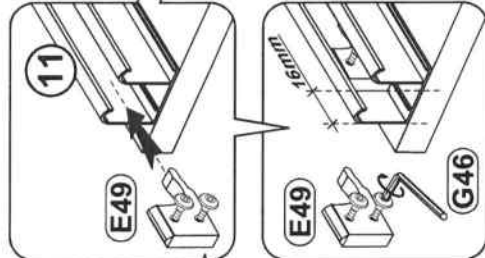
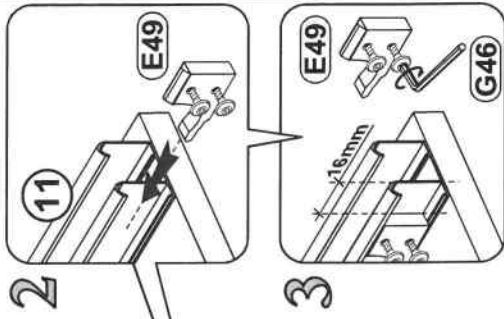
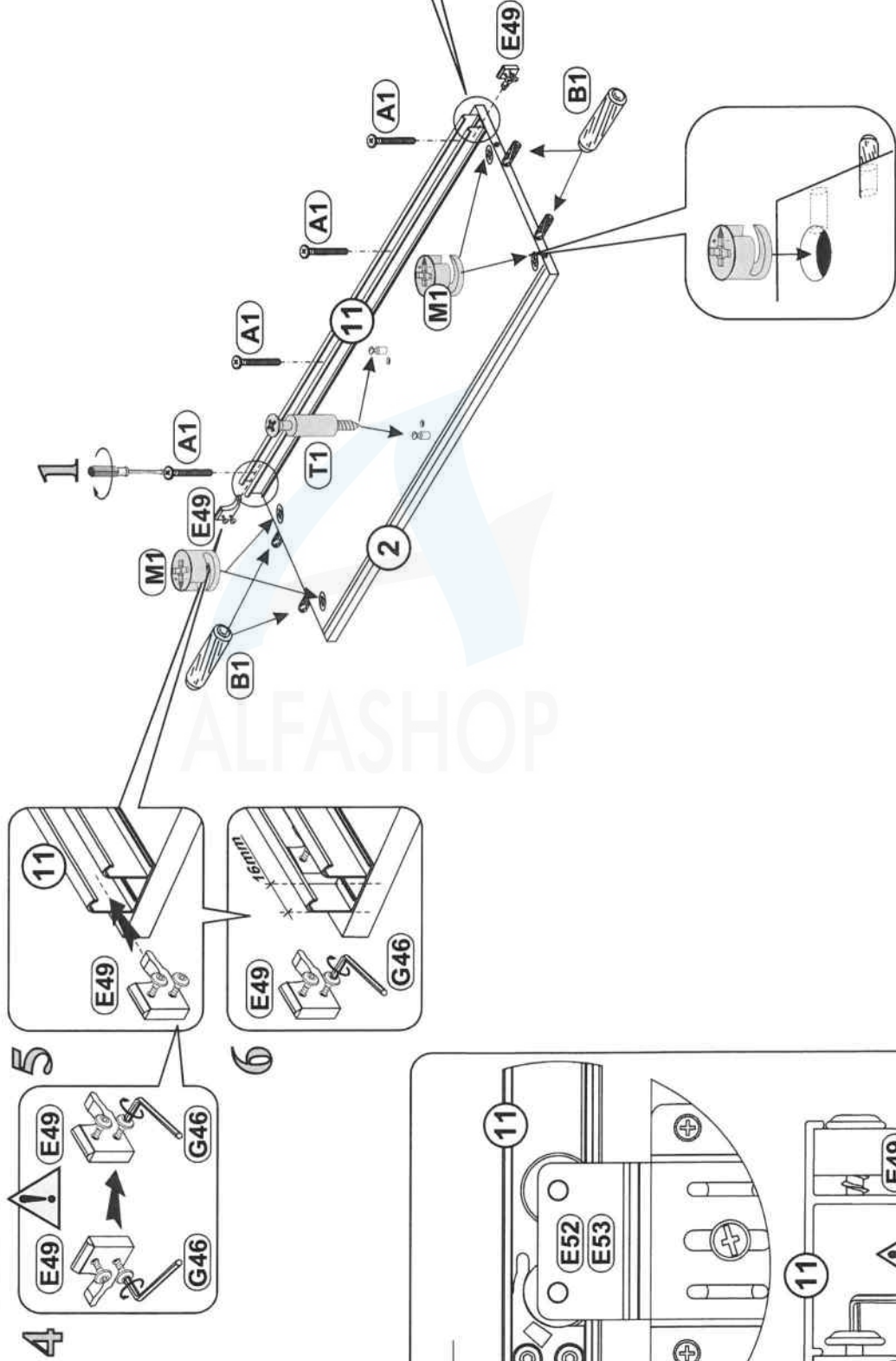

option "d"



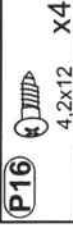

6 option "a" 

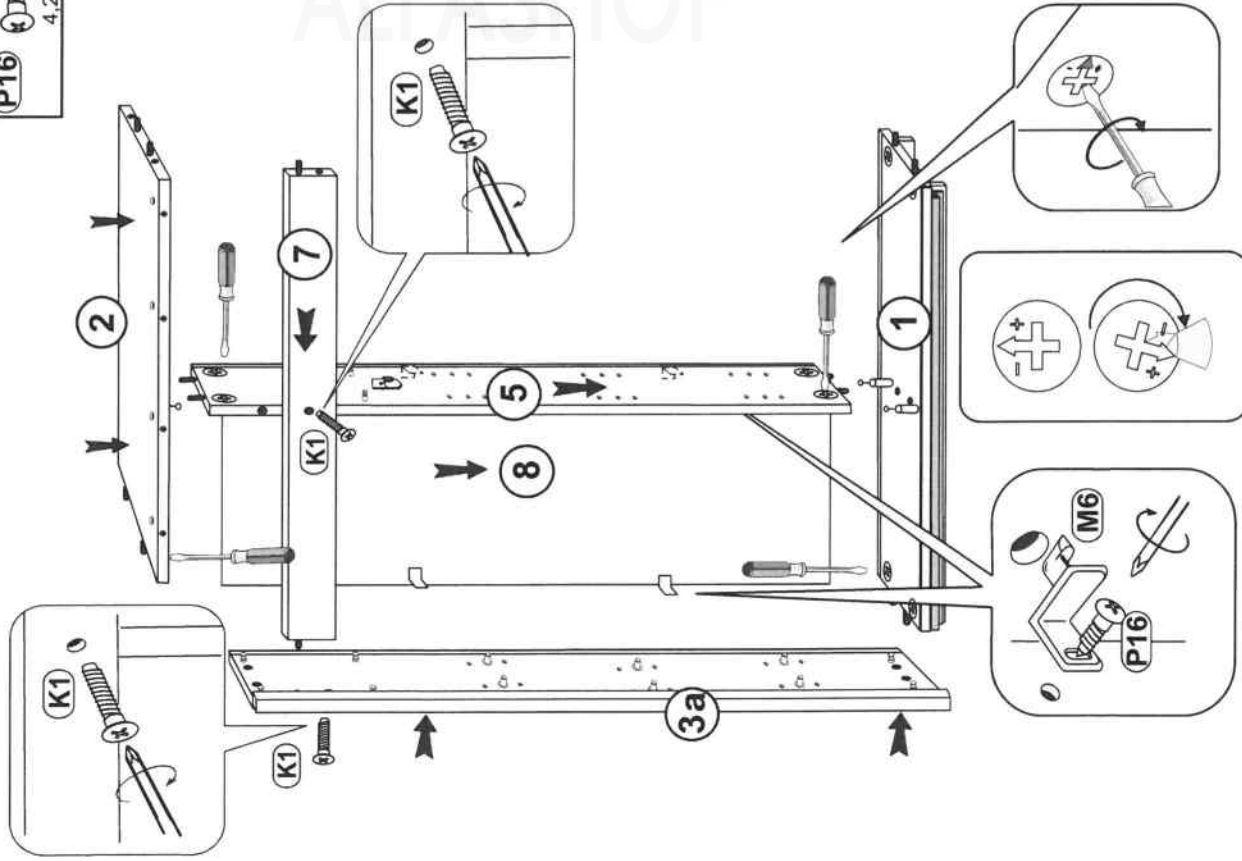
-  K1 7x50 X2
-  M6 X4
-  P16 4,2x12 X4



7

-  K1 7x50 X1
-  P16 4,2x12 X4
-  M6 X4

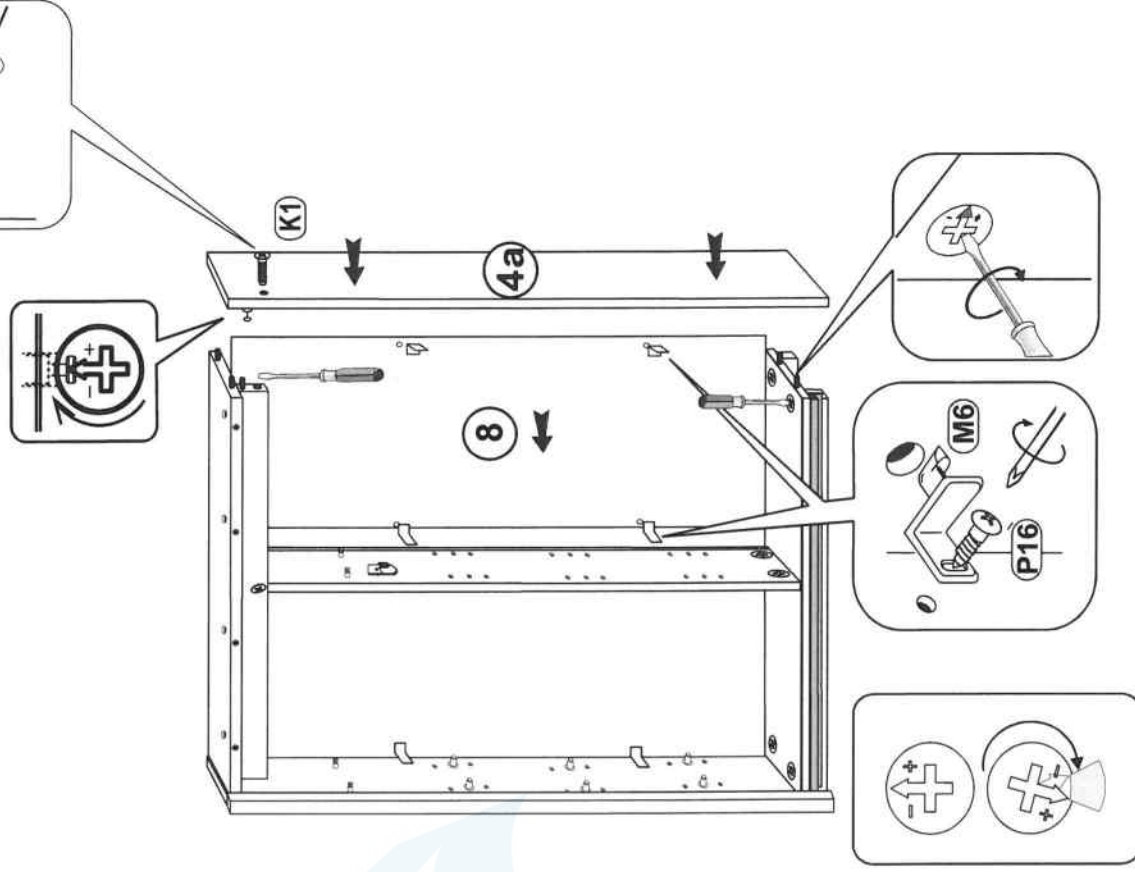



8

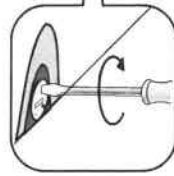
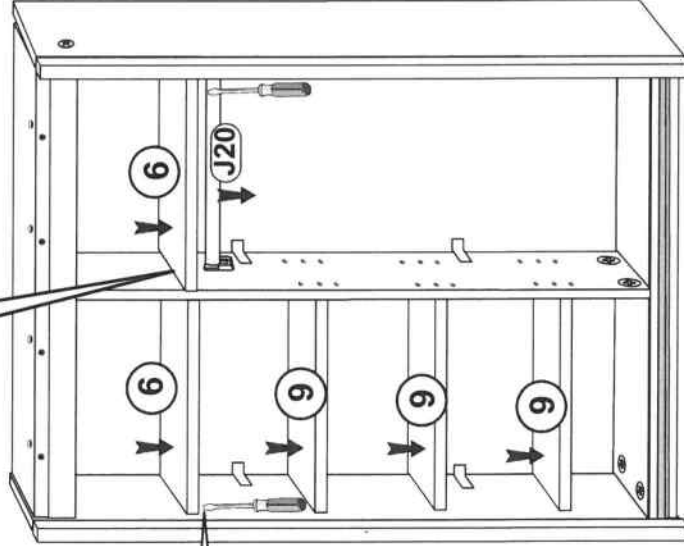
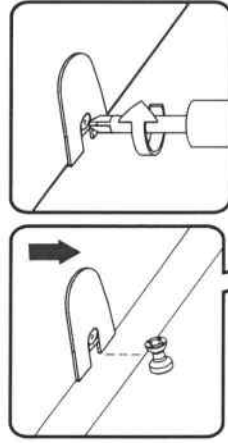

9

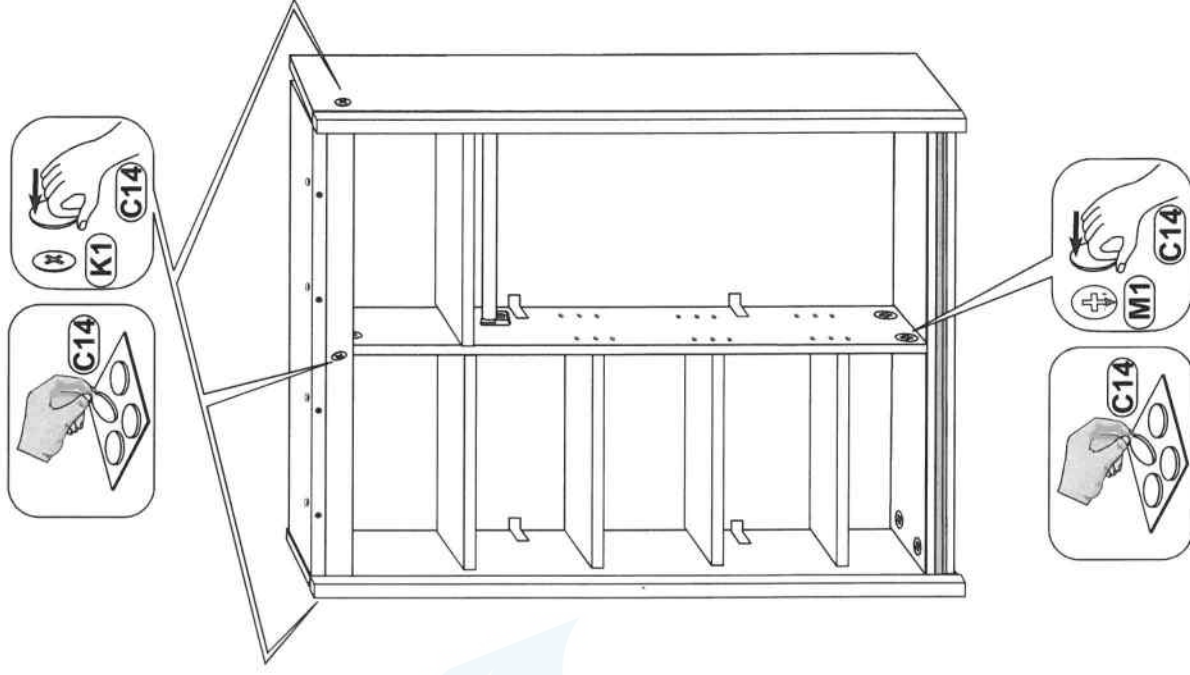

10

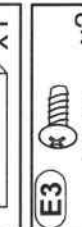
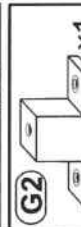

option "c" ⚠

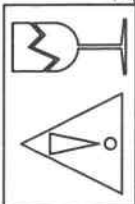
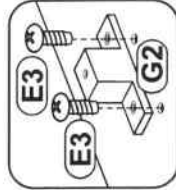
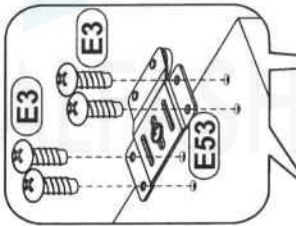
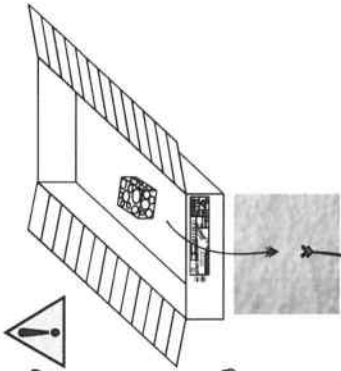
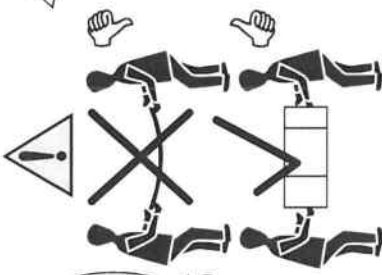

15

13

13

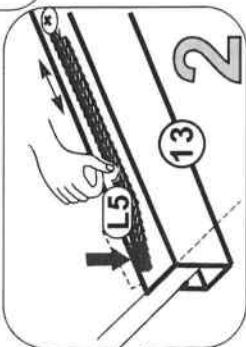

2

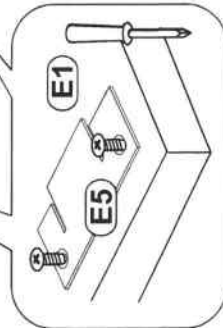

11

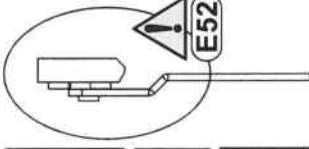
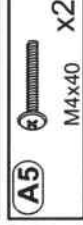
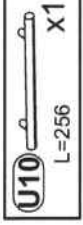
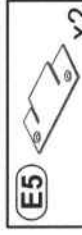
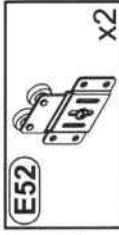

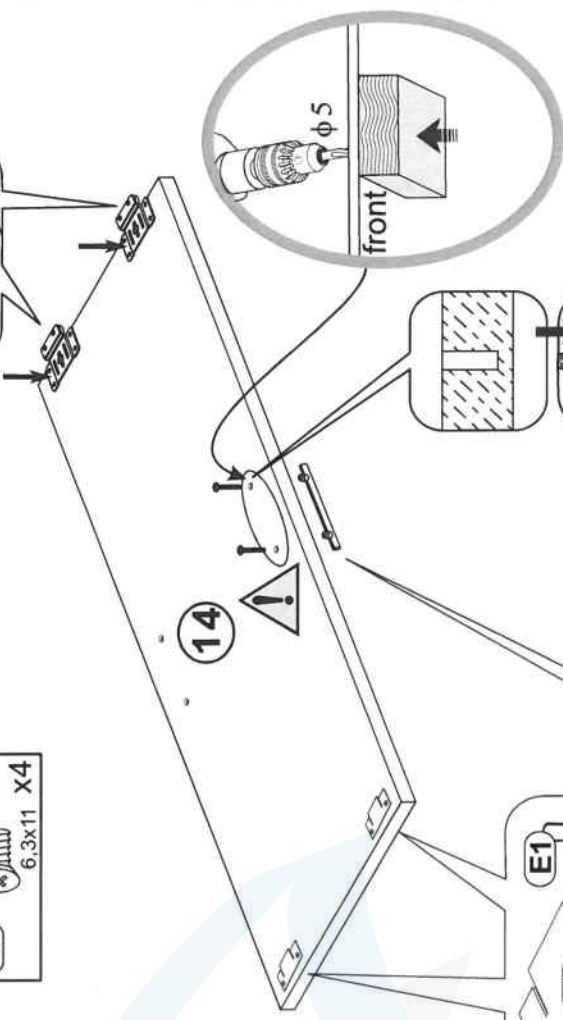
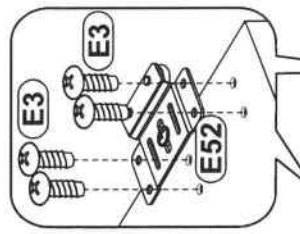

option "c" ⚠

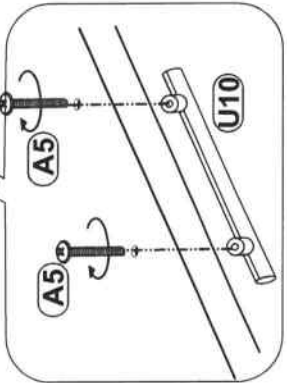
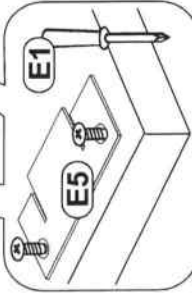
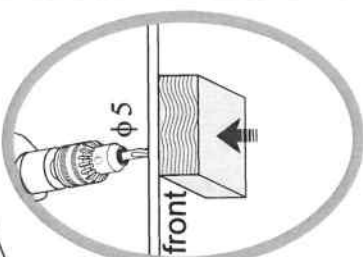

14

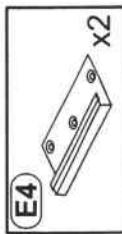

- 12**  x2
-  x4

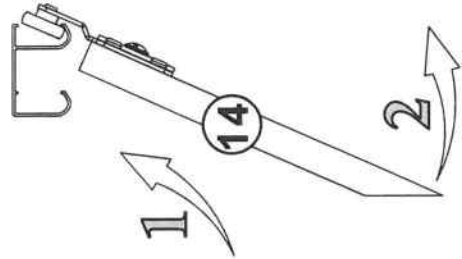

option "c" !

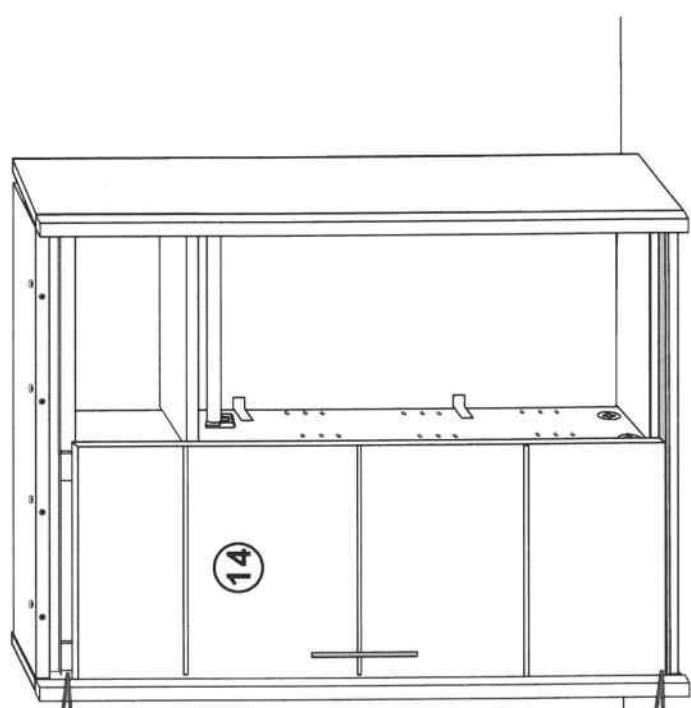
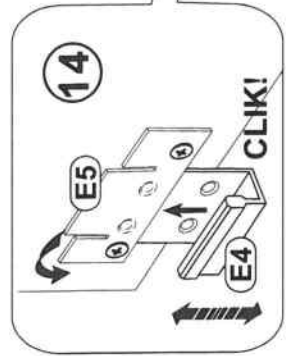
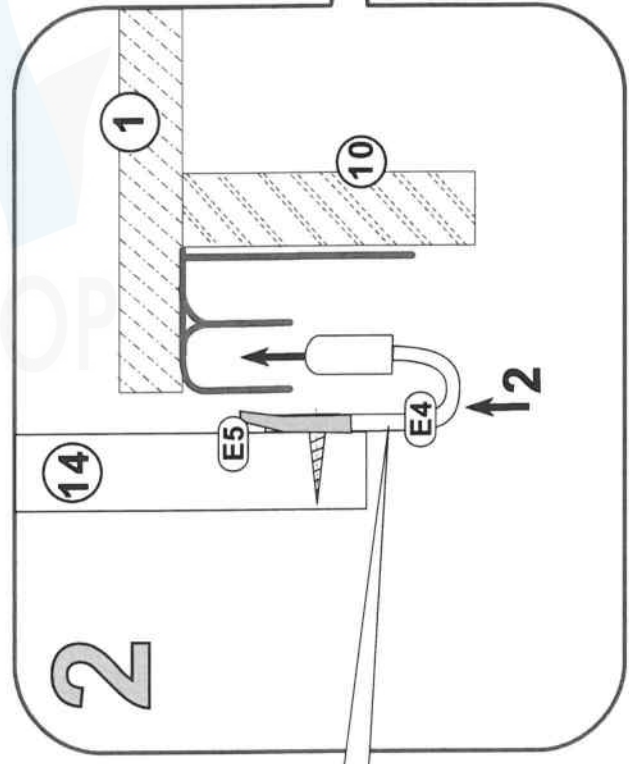
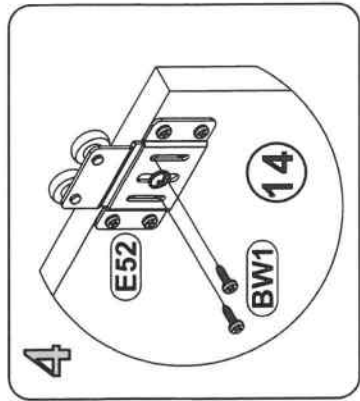
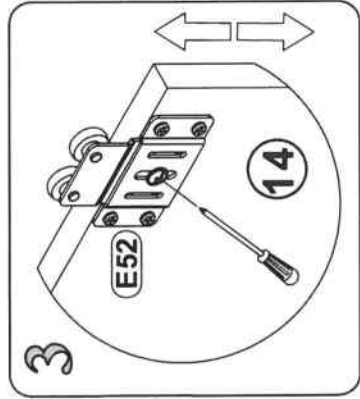
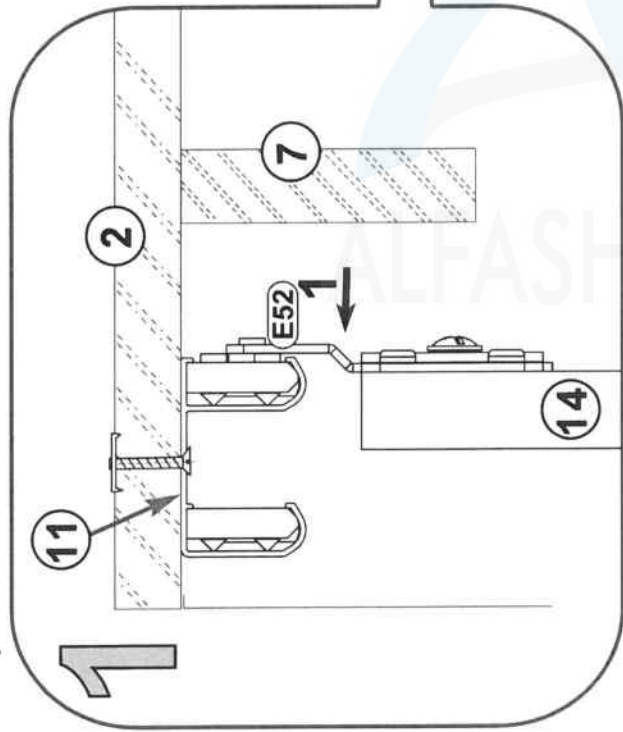

- 13**
- E3** x2
 - BW1** 4x16 x4

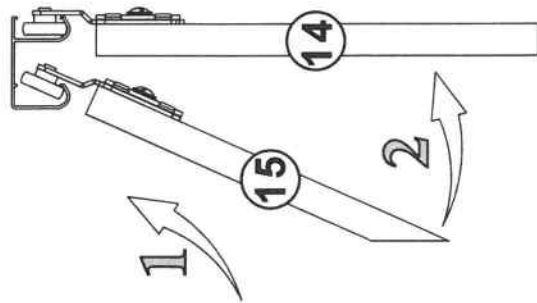

option "c"

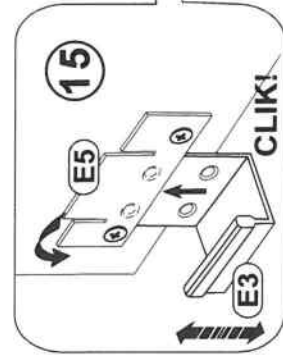
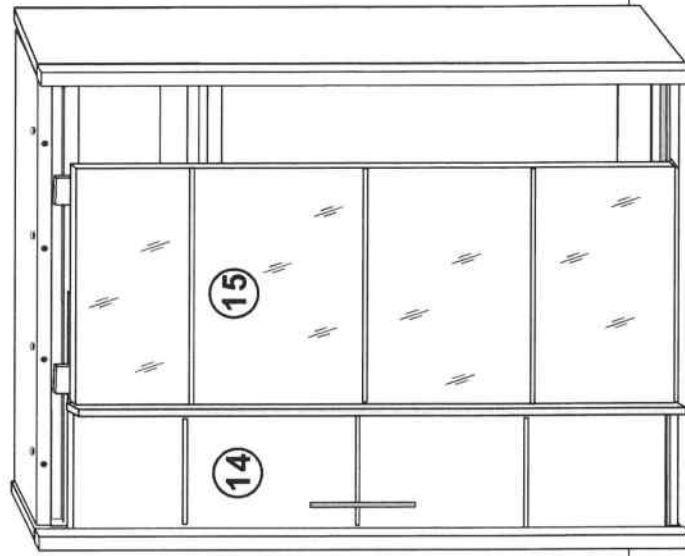
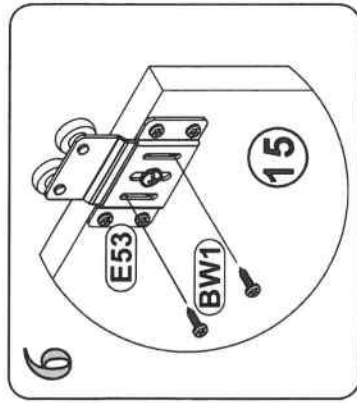
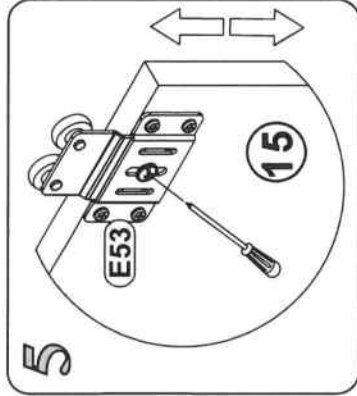
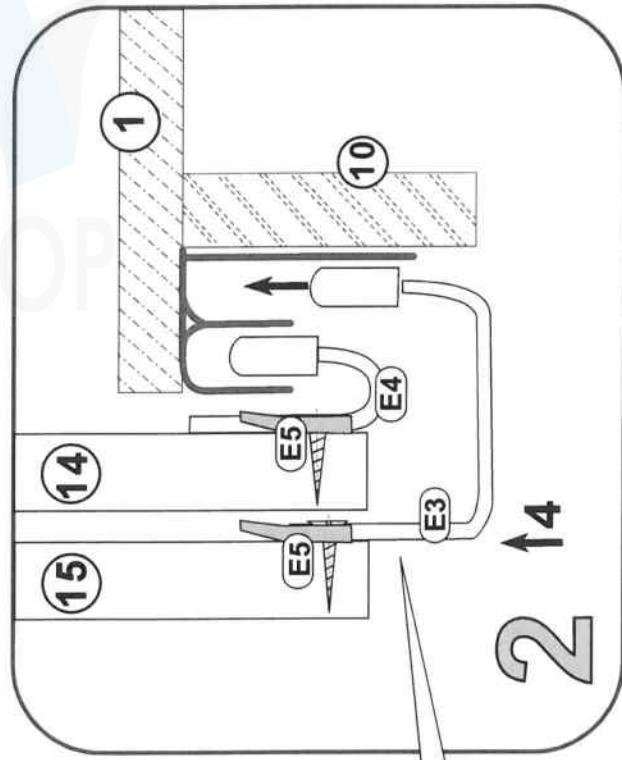
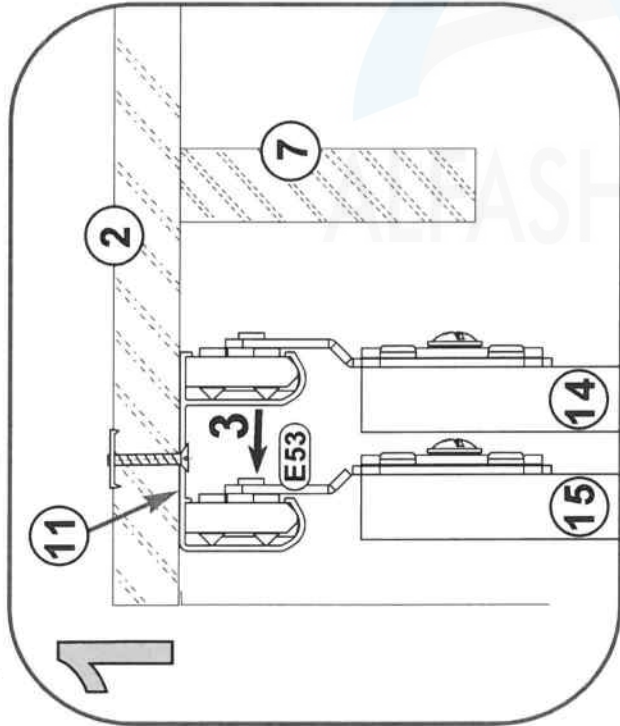

14

- E3 6.3x13 x8
- L5 1
- P13 3.5x13 mm x8
- E5 2
- E1 6.3x11 x4
- E53 2
- G2 1
- E3 6.3x13 x2

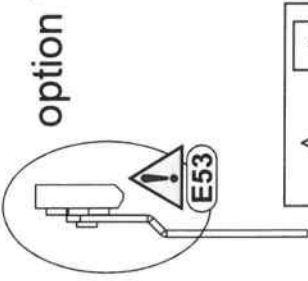

option "d"

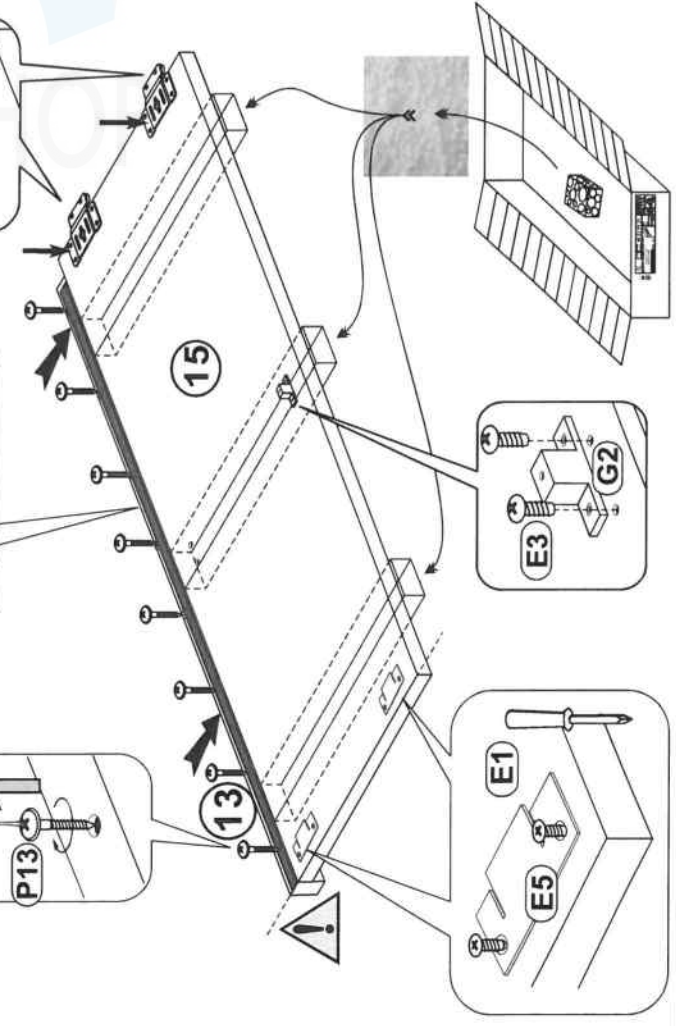
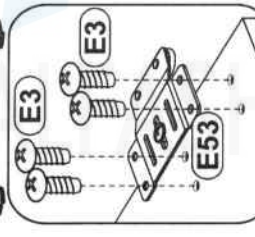
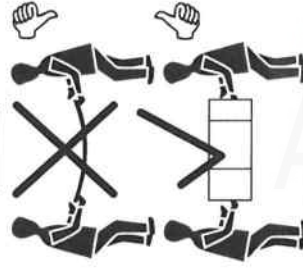

15

- E52 2
- E3 6.3x13 x8
- E5 2
- E1 6.3x11 x4

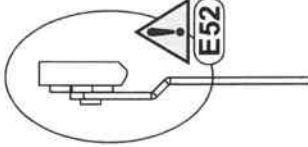

option "d"

- U10 L=256 x1
- A5 M4x40 x2

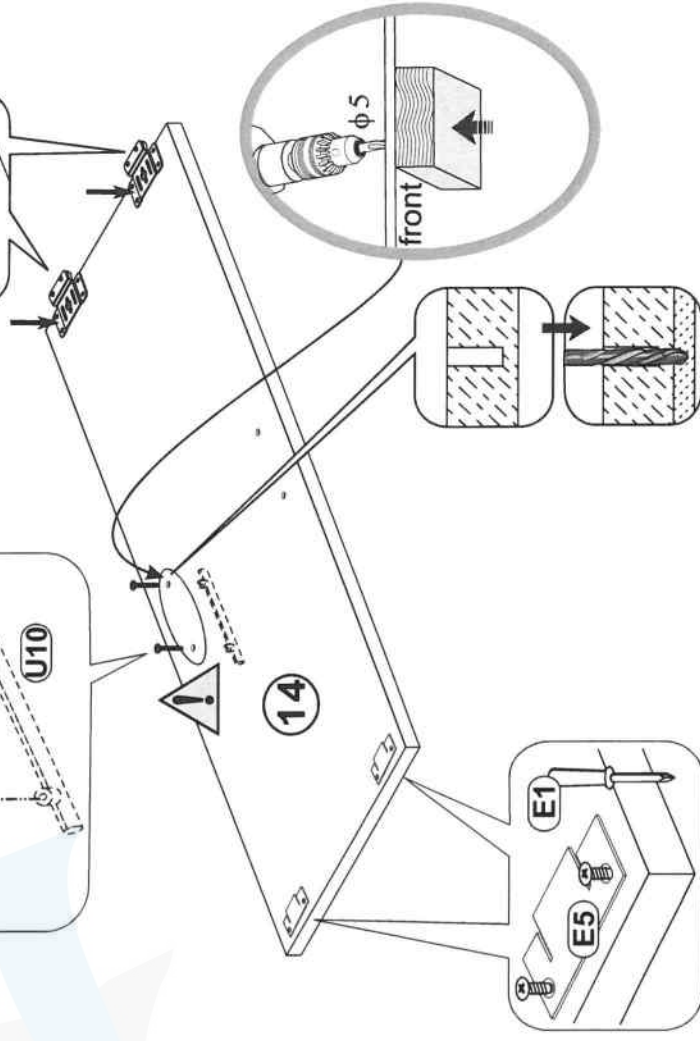
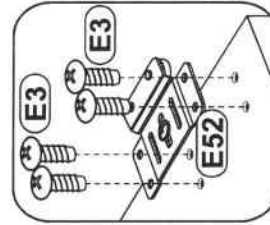
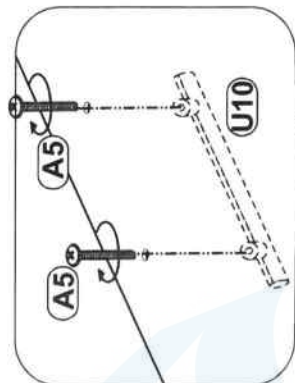

- 16**
- E4** x2
 - BW1** 4x16 x4

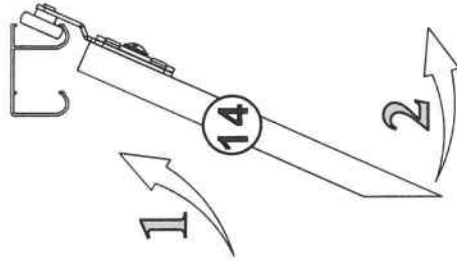

option "d" ⚠

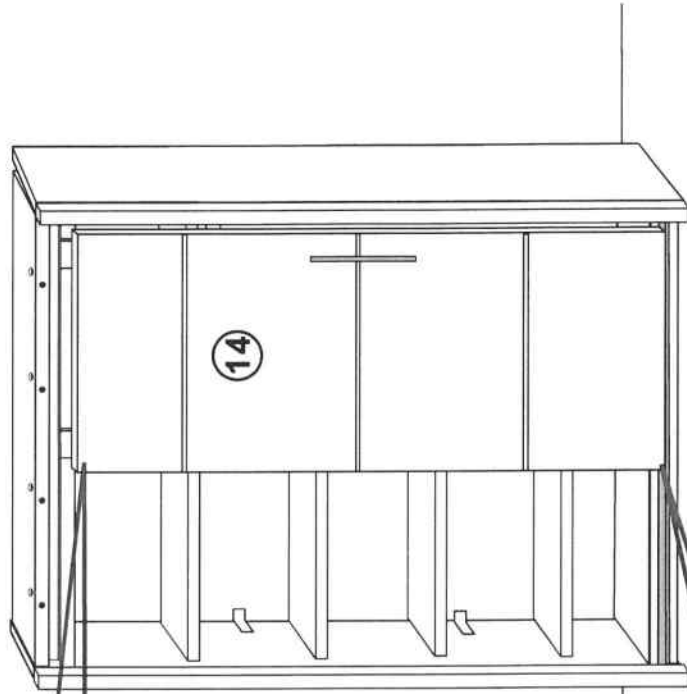
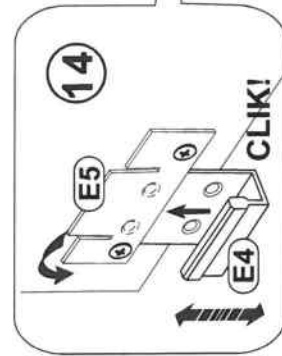
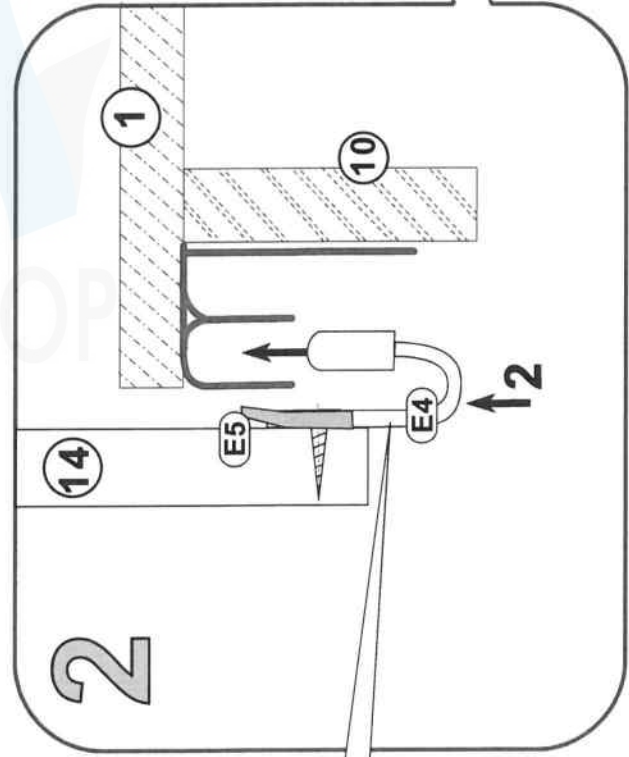
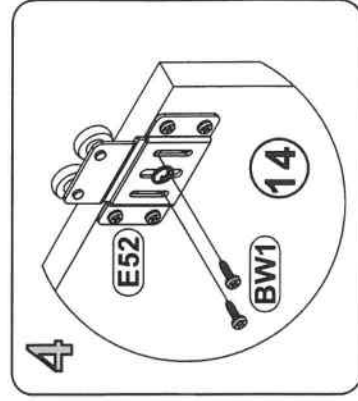
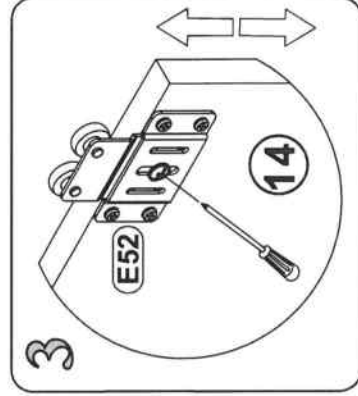
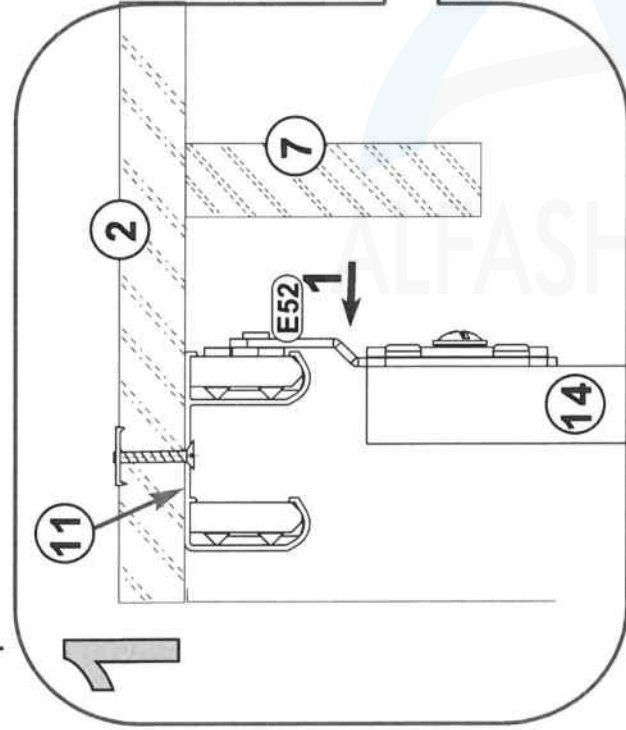

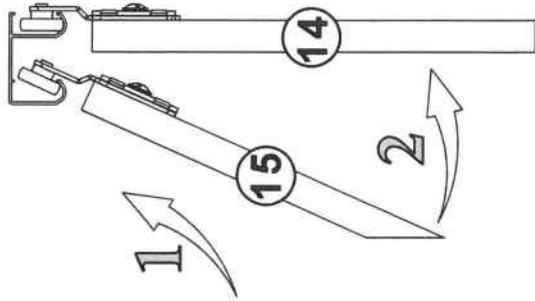
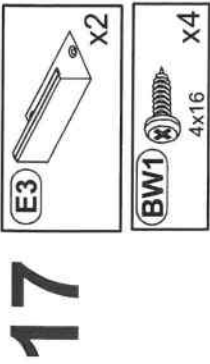

option "d"!

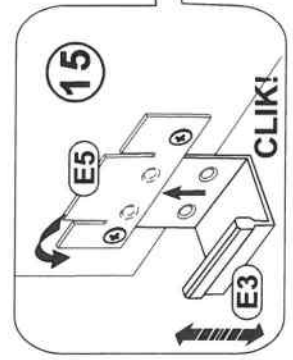
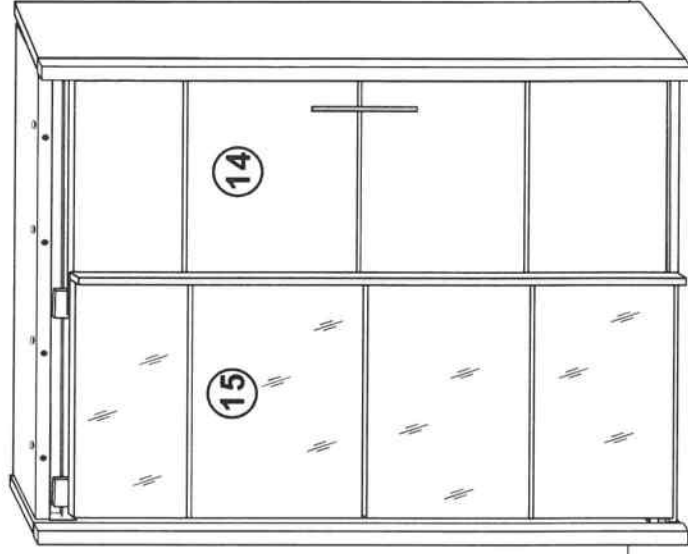
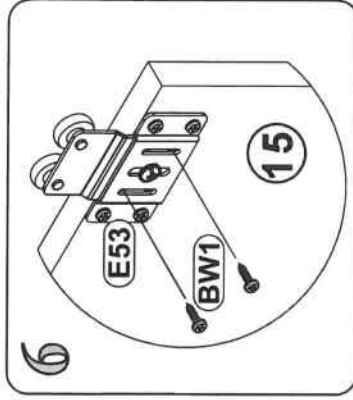
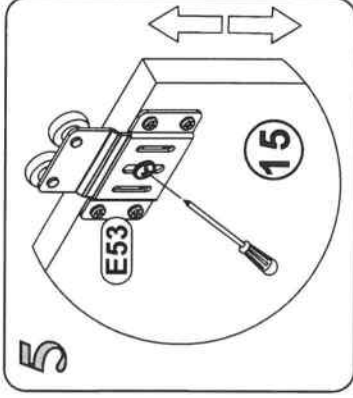
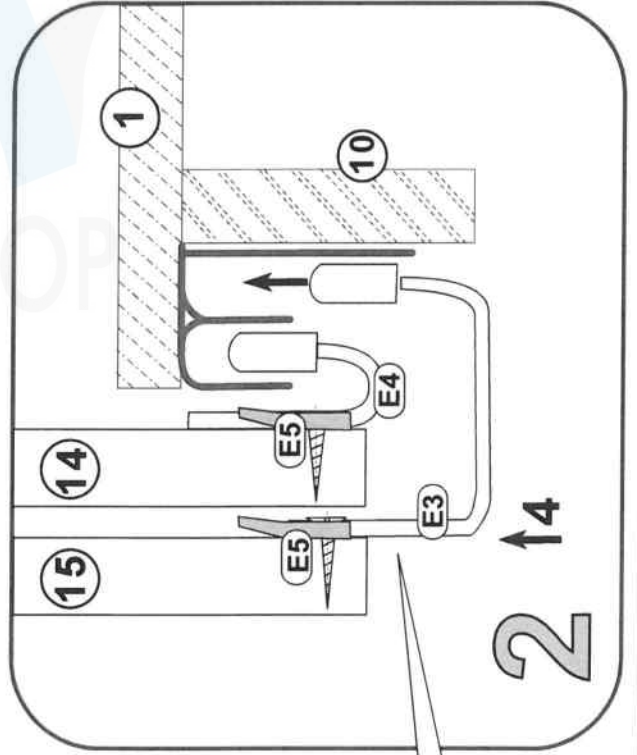
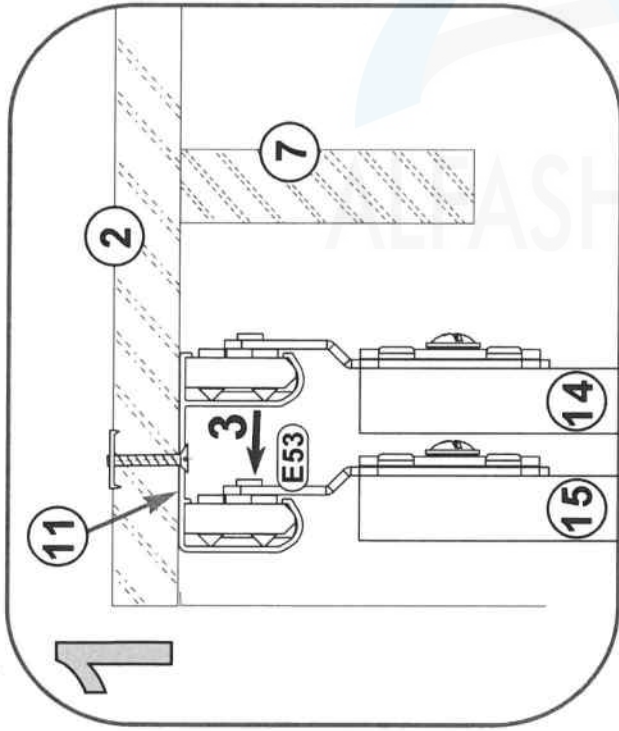

18



T1



x4

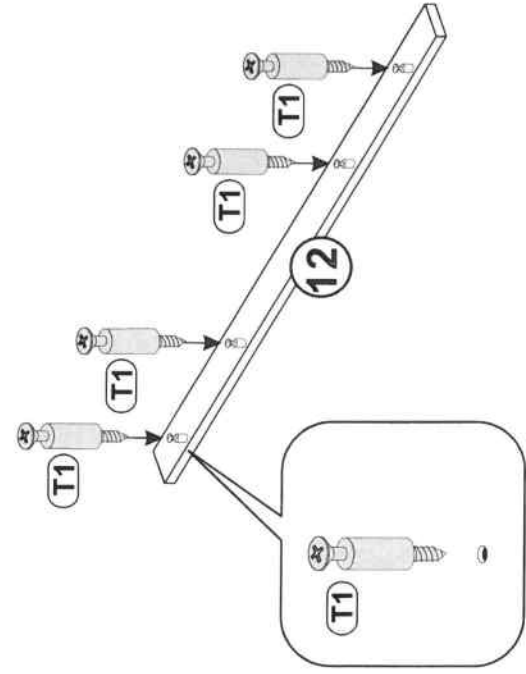

19



M1



x4

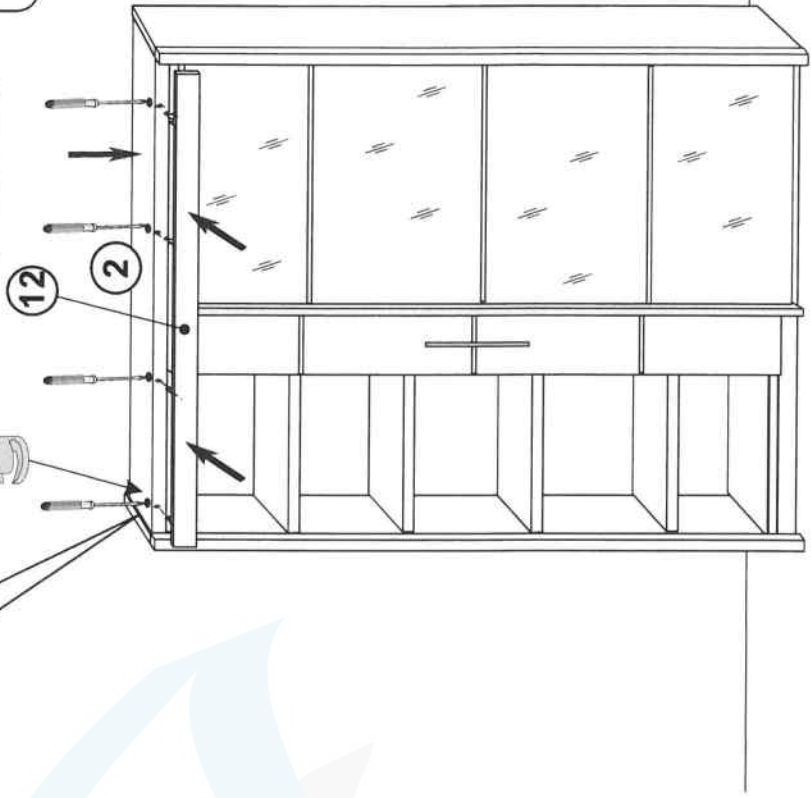
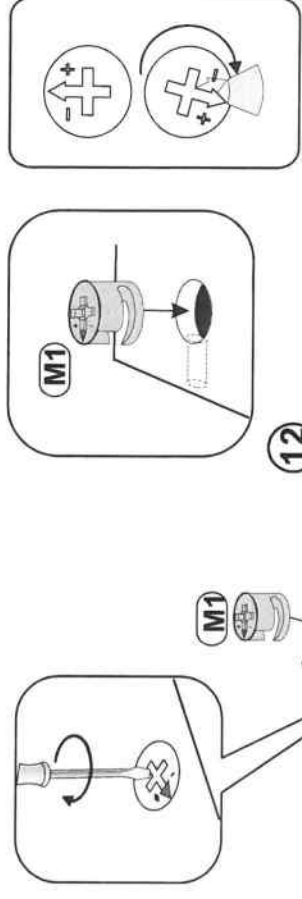

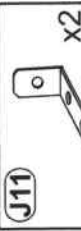
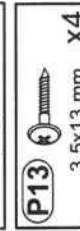
- L4**  x3
- J11**  x2
- P13**  3.5x13 mm x4

20

